

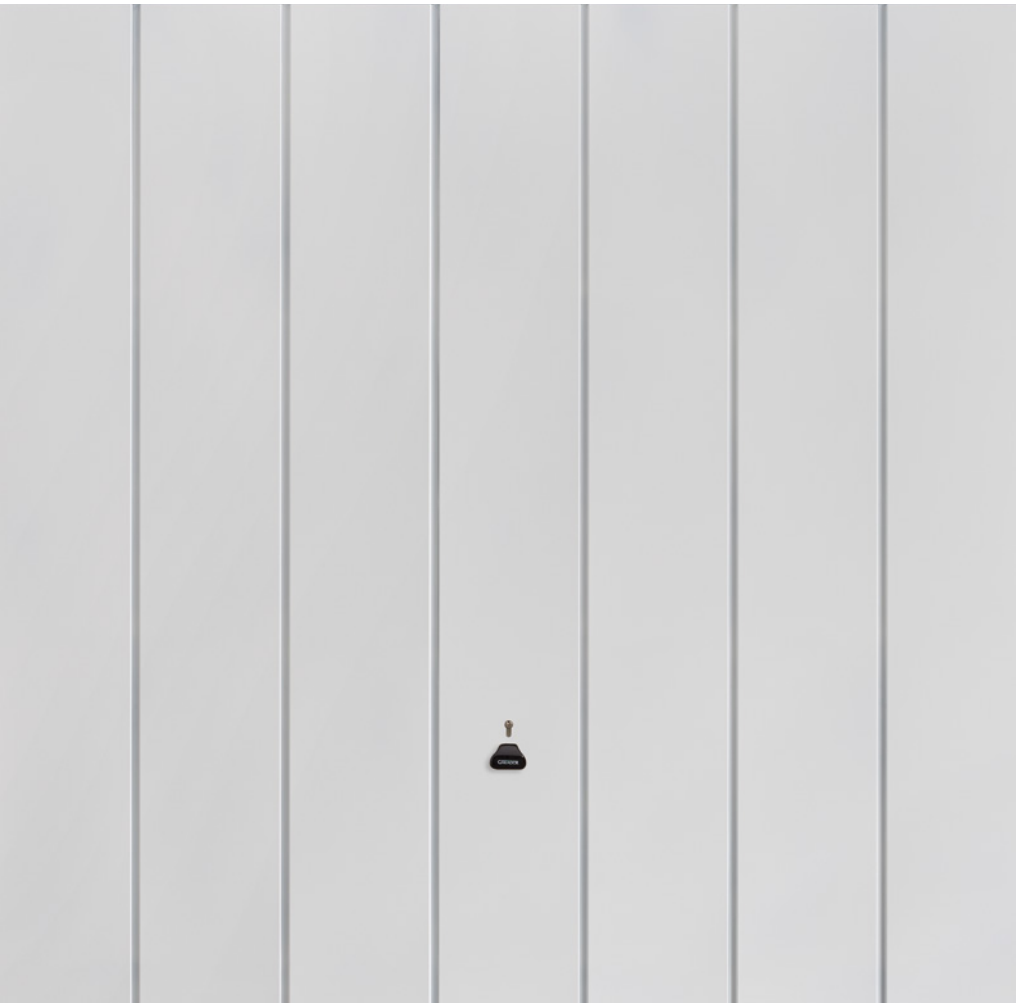

# The Garador Range Price List

**1st April 2024** Garage Doors and Automatic Operators



# General Information

All prices are quoted in £ Sterling, ex-works and exclusive of VAT.

Our doors are for residential purposes only and not for commercial use.

Please ensure that you order the correct size door to fit your opening as we are unable to accept the return of incorrectly ordered goods. Please contact Garador on 01935 443722 if you need assistance in calculating the correct size. A comprehensive range of the less common accessories and all spare parts are available either online or ask for a current spares price list if required.

Since the company's policy is one of continuous improvement of its products, we reserve the right to make any alterations in design, manufacture or price.

All business is governed by the Company's Standard Conditions and this document does not form any part of any contract with the company and statements contained in it should not be construed as representations or warranties.

For more information please visit  
[www.garador.co.uk](http://www.garador.co.uk)



# Contents

|  |    |
|--|----|
| Frame Dimensions for Panel Doors                       | 4  |
| Steel Panel Doors                                      | 6  |
| Guardian Range   | 16 |
| Design Range   | 18 |
| GRP Premier Panel Doors                                | 20 |
| Timber Panel Doors                                     | 26 |
| Steel and Timber Garage Side Doors                     | 36 |
| Steel, Timber and GRP Side-hinged Doors                | 38 |
| Garage Side Doors & Side-hinged Doors – Specifications | 45 |
| Steel Panel Doors – Specifications                     | 46 |
| Steel Sectional Garage Doors                           | 48 |
| Automation and Accessories                             | 72 |
| GaraRoll Roller Doors                                  | 78 |
| GaraGlide Roller Doors                                 | 82 |
| User Information / Care                                | 86 |
| Warranty   | 88 |
| Extracts from DHF consumer advice                      | 90 |

# Frame Dimensions for Panel Doors

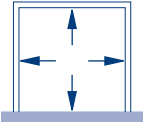
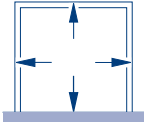
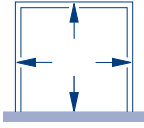
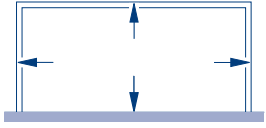
| Size Code |  |                |                    |                 |
|-----------|---|---|--|--|
|           | Internal frame size<br>On-site timber frame<br>Width x Height<br>(mm x mm)        | Pre-framed canopy door<br>overall frame sizes shown <sup>1</sup><br>Width x Height<br>(mm x mm) | Pre-framed retractable door<br>overall frame sizes shown <sup>1</sup><br>Width x Height<br>(mm x mm) | Frame kit for double door<br>overall frame sizes shown <sup>1</sup><br>Width x Height<br>(mm x mm) |
| 6660      | 1984 x 1830   | 2094 x 1888   | 2124 x 1888  | -  |
| 6663      | 1984 x 1905   | 2094 x 1963   | 2124 x 1963  | -  |
| 6664      | 1984 x 1931   | 2094 x 1989   | 2124 x 1989  | -  |
| 6666      | 1984 x 1981   | 2094 x 2039   | 2124 x 2039  | -  |
| 6670      | 1984 x 2136   | 2094 x 2194   | 2124 x 2194  | -  |
| 61064     | 2084 x 1931   | 2194 x 1989   | 2224 x 1989  | -  |
| 61066     | 2084 x 1981   | 2194 x 2039   | 2224 x 2039  | -  |
| 61070     | 2084 x 2136   | 2194 x 2194   | 2224 x 2194  | -  |
| 7060      | 2134 x 1830   | 2244 x 1888   | 2274 x 1888  | -  |
| 7063      | 2134 x 1905   | 2244 x 1963   | 2274 x 1963  | -  |
| 7064      | 2134 x 1931   | 2244 x 1989   | 2274 x 1989  | -  |
| 7066      | 2134 x 1981   | 2244 x 2039   | 2274 x 2039  | -  |
| 7068      | 2134 x 2036   | 2244 x 2094   | 2274 x 2094  | -  |
| 7070      | 2134 x 2136   | 2244 x 2194   | 2274 x 2194  | -  |
| 7072      | 2134 x 2186   | -   | 2274 x 2244  | -  |
| 7076      | 2134 x 2286   | -   | 2274 x 2344  | -  |
| 7163      | 2170 x 1905   | 2280 x 1963   | 2310 x 1963  | -  |
| 7164      | 2170 x 1931   | 2280 x 1989   | 2310 x 1989  | -  |
| 7166      | 2170 x 1981   | 2280 x 2039   | 2310 x 2039  | -  |
| 7168      | 2170 x 2036   | 2280 x 2094   | 2310 x 2094  | -  |
| 7170      | 2170 x 2136   | 2280 x 2194   | 2310 x 2194  | -  |
| 7172      | 2170 x 2186   | -   | 2310 x 2244  | -  |
| 7176      | 2170 x 2286   | -   | 2310 x 2344  | -  |
| 7364      | 2224 x 1931   | 2334 x 1989   | 2364 x 1989  | -  |
| 7366      | 2224 x 1981   | 2334 x 2039   | 2364 x 2039  | -  |
| 7368      | 2224 x 2036   | 2334 x 2094   | 2364 x 2094  | -  |
| 7370      | 2224 x 2136   | 2334 x 2194   | 2364 x 2194  | -  |
| 7563      | 2259 x 1905   | 2369 x 1963   | 2399 x 1963  | -  |
| 7564      | 2259 x 1931   | 2369 x 1989   | 2399 x 1989  | -  |
| 7566      | 2259 x 1981   | 2369 x 2039   | 2399 x 2039  | -  |
| 7568      | 2259 x 2036   | 2369 x 2094   | 2399 x 2094  | -  |
| 7570      | 2259 x 2136   | 2369 x 2194   | 2399 x 2194  | -  |
| 7572      | 2259 x 2186   | -   | 2399 x 2244  | -  |
| 7576      | 2259 x 2286   | -   | 2399 x 2344  | -  |
| 7663      | 2284 x 1905   | 2394 x 1963   | 2424 x 1963  | -  |
| 7664      | 2284 x 1931   | 2394 x 1989   | 2424 x 1989  | -  |
| 7666      | 2284 x 1981   | 2394 x 2039   | 2424 x 2039  | -  |
| 7668      | 2284 x 2036   | 2394 x 2094   | 2424 x 2094  | -  |
| 7670      | 2284 x 2136   | 2394 x 2194   | 2424 x 2194  | -  |
| 7672      | 2284 x 2186   | -   | 2424 x 2244  | -  |
| 7676      | 2284 x 2286   | -   | 2424 x 2344  | -  |
| 8063      | 2439 x 1905   | 2549 x 1963   | 2579 x 1963  | -  |
| 8064      | 2439 x 1931   | 2549 x 1989   | 2579 x 1989  | -  |
| 8066      | 2439 x 1981   | 2549 x 2039   | 2579 x 2039  | -  |
| 8068      | 2439 x 2036   | 2549 x 2094   | 2579 x 2094  | -  |
| 8070      | 2439 x 2136   | 2549 x 2194   | 2579 x 2194  | -  |

<sup>1</sup> No fitting clearance allowed. If door is fitted between the brickwork a minimum of 10 mm clearance over the width and 5 mm over the height should be added to the overall frame size when selecting the door.

GARADOR Frame Dimensions for Panel Doors

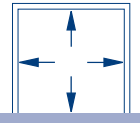
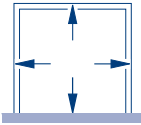
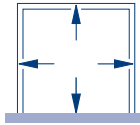
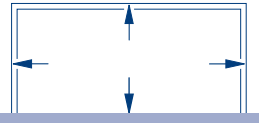
| Size Code | <br>Internal frame size<br>On-site timber frame<br>Width x Height<br>(mm x mm) | <br>Pre-framed canopy door<br>overall frame sizes shown <sup>1</sup><br>Width x Height<br>(mm x mm) | <br>Pre-framed retractable door<br>overall frame sizes shown <sup>1</sup><br>Width x Height<br>(mm x mm) | <br>Frame kit for double door<br>overall frame sizes shown <sup>1</sup><br>Width x Height<br>(mm x mm) |
|-----------|---|--|--|---|
| 8072      | 2439 x 2186   | –  | 2579 x 2244  | –   |
| 8076      | 2439 x 2286   | –  | 2579 x 2344  | –   |
| 8666      | 2590 x 1981   | –  | 2730 x 2039  | –   |
| 8670      | 2590 x 2136   | –  | 2730 x 2194  | –   |
| 8676      | 2590 x 2286   | –  | 2730 x 2344  | –   |
| 9066      | 2744 x 1981   | –  | 2884 x 2039  | –   |
| 9070      | 2744 x 2136   | –  | 2884 x 2194  | –   |
| 9076      | 2744 x 2286   | –  | 2884 x 2344  | –   |
| 1066      | 3049 x 1981   | –  | 3189 x 2039  | –   |
| 1070      | 3049 x 2136   | –  | 3189 x 2194  | –   |
| 1076      | 3049 x 2286   | –  | –  | 3189 x 2344   |
| 1166      | 3354 x 1981   | –  | –  | 3494 x 2039   |
| 1170      | 3354 x 2136   | –  | –  | 3494 x 2194   |
| 1176      | 3354 x 2286   | –  | –  | 3494 x 2344   |
| 1266      | 3659 x 1981   | –  | –  | 3799 x 2039   |
| 1270      | 3659 x 2136   | –  | –  | 3799 x 2194   |
| 1276      | 3659 x 2286   | –  | –  | 3799 x 2344   |
| 1366      | 3964 x 1981   | –  | –  | 4104 x 2039   |
| 1370      | 3964 x 2136   | –  | –  | 4104 x 2194   |
| 1376      | 3964 x 2286   | –  | –  | 4104 x 2344   |
| 1466      | 4269 x 1981   | –  | –  | 4409 x 2039   |
| 1470      | 4269 x 2136   | –  | –  | 4409 x 2194   |
| 1566      | 4574 x 1981   | –  | –  | 4714 x 2039   |
| 1570      | 4574 x 2136   | –  | –  | 4714 x 2194   |
| 1666      | 4879 x 1981   | –  | –  | 5019 x 2039   |
| 1670      | 4879 x 2136   | –  | –  | 5019 x 2194   |

<sup>1</sup> No fitting clearance allowed. If door is fitted between the brickwork a minimum of 10 mm clearance over the width and 5 mm over the height should be added to the overall frame size when selecting the door.

# Steel Panel Doors

## Surface

High quality powder or foil coated finish.

Please note: panel doors are produced with appearance in mind. This may result in some small gaps which could allow water ingress especially in exposed locations.

## Colours

All doors supplied in Traffic White (RAL 9016) as standard.

Optional colours available:

- |                          |                          |                              |                             |
|--------------------------|--------------------------|------------------------------|-----------------------------|
| - Light Ivory (RAL 1015) | - Pigeon Blue (RAL 5014) | - Anthracite Grey (RAL 7016) | - Burgundy Brown            |
| - Ruby Red (RAL 3003)    | - Moss Green (RAL 6005)  | - Terra Brown (RAL 8028)     | - Golden Brown              |
| - Signal Blue (RAL 5005) | - Fir Green (RAL 6009)   | - Jet Black (RAL 9005)       | - Chartwell Green (BS 4800) |
| - Steel Blue (RAL 5011)  | - Slate Grey (RAL 7015)  | - Window Grey (RAL 7040)     | - Agate Grey (RAL 7038)     |
| - Stone Grey (RAL 7030)  | - Light grey (RAL 7035)  |                              |                             |

Timber effect finishes are available in either a Golden Oak or Rosewood foil coat timber effect.

## Handle

Black handle as standard, optional handles are available. Doors can be supplied undrilled and without handle and locking mechanism for use with electric operator (not available on Wentwood or Sherwood doors). This option makes the door purpose made and will therefore increase lead-time, please specify clearly on order.

## Terminology

**Nominal Door Size:** This is the actual door panel size plus the fitting tolerances. The nominal door size should be used for internal dimensions of a timber frame.

**Size Code:** This has traditionally been used to order doors. This may not be the actual door size.

## Stock availability

Prices in bold show stock doors in Traffic White (unless specified) and all other prices relate to non-stock doors.

## Packaging

All doors are supplied unwrapped as standard, with optional poly-wrapping available.

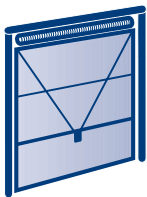

### Canopy gearing (shown as C)

Canopy gear is available for all single doors providing a reliable and affordable gearing solution, with no tracks running back into the garage.

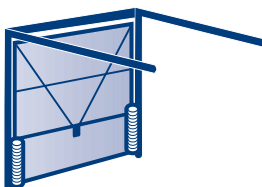

### Retractable gearing (shown as R)

Retractable gear is available for all single and double doors providing a reliable and affordable gearing solution, with tracks running back into the garage.

Single door

Nominal Door Size  
Width x Height  
(mm x mm)

Size  
Code

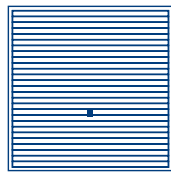

Horizon

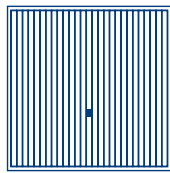

Carlton

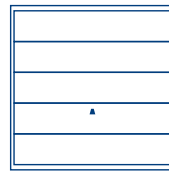

Ascot

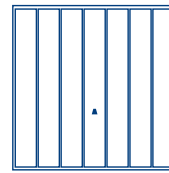

Windsor

|             | Size Code | Horizon                 |                         | Carlton                  |                          | Ascot                    |                          | Windsor     |             |
|-------------|-----------|-------------------------|-------------------------|--------------------------|--------------------------|--------------------------|--------------------------|-------------|-------------|
|             |           | C                       | R                       | C                        | R                        | C                        | R                        | C           | R           |
| 1984 x 1830 | 6660      | 881                     | 930                     | 998                      | 1047                     | -                        | -                        | -           | -           |
| 1984 x 1905 | 6663      | 881                     | 930                     | 998                      | 1047                     | -                        | -                        | -           | -           |
| 1984 x 1931 | 6664      | <b>881</b>              | <b>930</b>              | 998                      | 1047                     | -                        | -                        | -           | -           |
| 1984 x 1981 | 6666      | <b>834</b>              | <b>883</b>              | 948                      | 997                      | -                        | -                        | -           | -           |
| 1984 x 2136 | 6670      | 834                     | 883                     | 948                      | 997                      | 947                      | 998                      | -           | -           |
| 2084 x 1931 | 61064     | <b>850</b>              | <b>899</b>              | 947                      | 996                      | -                        | -                        | -           | -           |
| 2084 x 1981 | 61066     | <b>874</b>              | <b>923</b>              | <b>947</b>               | <b>996</b>               | 997                      | 1046                     | -           | -           |
| 2084 x 2136 | 61070     | <b>905</b>              | <b>954</b>              | <b>968</b>               | <b>1017</b>              | 1018                     | 1067                     | -           | -           |
| 2134 x 1830 | 7060      | <b>906</b>              | <b>955</b>              | 1025                     | 1074                     | -                        | -                        | -           | -           |
| 2134 x 1905 | 7063      | <b>906</b>              | <b>955</b>              | 1025                     | 1074                     | -                        | -                        | -           | -           |
| 2134 x 1931 | 7064      | <b>861</b>              | <b>910</b>              | <b>954</b>               | <b>1003</b>              | -                        | -                        | -           | -           |
| 2134 x 1981 | 7066      | <b>798</b> <sup>1</sup> | <b>847</b> <sup>1</sup> | <b>922</b> <sup>1</sup>  | <b>971</b> <sup>1</sup>  | <b>972</b> <sup>1</sup>  | <b>1021</b> <sup>1</sup> | <b>1136</b> | <b>1185</b> |
| 2134 x 2036 | 7068      | 910                     | 959                     | 1008                     | 1057                     | -                        | -                        | 1154        | 1203        |
| 2134 x 2136 | 7070      | <b>875</b> <sup>1</sup> | <b>924</b> <sup>1</sup> | <b>961</b> <sup>1</sup>  | <b>1010</b> <sup>1</sup> | <b>1085</b> <sup>1</sup> | <b>1134</b> <sup>1</sup> | <b>1172</b> | <b>1221</b> |
| 2134 x 2186 | 7072      | -                       | 993                     | -                        | 1081                     | -                        | -                        | 1243        | 1292        |
| 2134 x 2286 | 7076      | -                       | 1111                    | -                        | 1192                     | -                        | -                        | -           | -           |
| 2170 x 1905 | 7163      | 861                     | 910                     | 954                      | 1003                     | -                        | -                        | -           | -           |
| 2170 x 1931 | 7164      | <b>861</b>              | <b>910</b>              | 954                      | 1003                     | -                        | -                        | -           | -           |
| 2170 x 1981 | 7166      | <b>798</b>              | <b>847</b>              | <b>922</b>               | <b>971</b>               | 972                      | 1021                     | 1136        | 1185        |
| 2170 x 2036 | 7168      | 910                     | 959                     | 1008                     | 1057                     | -                        | -                        | -           | -           |
| 2170 x 2136 | 7170      | <b>875</b>              | <b>924</b>              | <b>961</b>               | <b>1010</b>              | 1085                     | 1134                     | 1172        | 1221        |
| 2170 x 2186 | 7172      | -                       | 993                     | -                        | 1081                     | -                        | -                        | -           | -           |
| 2170 x 2286 | 7176      | -                       | 1229                    | -                        | 1295                     | -                        | -                        | -           | -           |
| 2224 x 1905 | 7363      | 938                     | 987                     | 997                      | 1046                     | -                        | -                        | -           | -           |
| 2224 x 1931 | 7364      | <b>938</b>              | <b>987</b>              | 997                      | 1046                     | -                        | -                        | -           | -           |
| 2224 x 1981 | 7366      | <b>941</b>              | <b>990</b>              | 1001                     | 1050                     | 1051                     | 1100                     | -           | -           |
| 2224 x 2036 | 7368      | 980                     | 1029                    | 1063                     | 1112                     | -                        | -                        | -           | -           |
| 2224 x 2136 | 7370      | 955                     | 1004                    | <b>1014</b>              | <b>1063</b>              | 1064                     | 1113                     | -           | -           |
| 2259 x 1905 | 7563      | 929                     | 978                     | 1008                     | 1057                     | -                        | -                        | -           | -           |
| 2259 x 1931 | 7564      | <b>929</b>              | <b>978</b>              | 1008                     | 1057                     | -                        | -                        | -           | -           |
| 2259 x 1981 | 7566      | <b>938</b>              | <b>987</b>              | <b>1008</b>              | <b>1057</b>              | 1112                     | 1161                     | 1214        | 1263        |
| 2259 x 2036 | 7568      | 980                     | 1029                    | 1063                     | 1112                     | -                        | -                        | 1263        | 1312        |
| 2259 x 2136 | 7570      | <b>1065</b>             | <b>1114</b>             | <b>1135</b>              | <b>1184</b>              | 1263                     | 1312                     | 1313        | 1362        |
| 2259 x 2186 | 7572      | -                       | 1195                    | -                        | 1223                     | -                        | -                        | -           | 1449        |
| 2259 x 2286 | 7576      | -                       | 1324                    | -                        | 1295                     | -                        | -                        | -           | -           |
| 2284 x 1905 | 7663      | 938                     | 987                     | 1034                     | 1083                     | -                        | -                        | -           | -           |
| 2284 x 1931 | 7664      | <b>938</b>              | <b>987</b>              | 1034                     | 1083                     | -                        | -                        | -           | -           |
| 2284 x 1981 | 7666      | <b>938</b>              | <b>987</b>              | <b>1034</b>              | <b>1083</b>              | 1112                     | 1161                     | 1214        | 1263        |
| 2284 x 2036 | 7668      | 992                     | 1041                    | 1092                     | 1141                     | -                        | -                        | 1263        | 1312        |
| 2284 x 2136 | 7670      | <b>1069</b>             | <b>1118</b>             | <b>1135</b> <sup>1</sup> | <b>1184</b> <sup>1</sup> | 1247                     | 1296                     | 1313        | 1362        |
| 2284 x 2186 | 7672      | -                       | 1197                    | -                        | 1266                     | -                        | -                        | -           | 1449        |
| 2284 x 2286 | 7676      | -                       | 1328                    | -                        | 1295                     | -                        | -                        | -           | -           |
| 2439 x 1905 | 8063      | 1081                    | 1130                    | 1225                     | 1274                     | -                        | -                        | -           | -           |
| 2439 x 1931 | 8064      | <b>1081</b>             | <b>1130</b>             | 1225                     | 1274                     | -                        | -                        | -           | -           |
| 2439 x 1981 | 8066      | <b>1081</b>             | <b>1130</b>             | <b>1225</b>              | <b>1274</b>              | 1238                     | 1287                     | 1409        | 1458        |
| 2439 x 2036 | 8068      | 1141                    | 1190                    | 1291                     | 1340                     | -                        | -                        | 1429        | 1478        |
| 2439 x 2136 | 8070      | <b>1105</b>             | <b>1154</b>             | <b>1265</b> <sup>1</sup> | <b>1314</b> <sup>1</sup> | 1279 <sup>1</sup>        | 1328 <sup>1</sup>        | 1449        | 1498        |
| 2439 x 2186 | 8072      | -                       | 1233                    | -                        | 1406                     | -                        | -                        | -           | 1586        |
| 2439 x 2286 | 8076      | -                       | 1296                    | -                        | 1410                     | -                        | -                        | -           | -           |
| 2590 x 1981 | 8666      | -                       | 1247                    | -                        | 1406                     | -                        | -                        | -           | -           |
| 2590 x 2136 | 8670      | -                       | 1291                    | -                        | 1463                     | -                        | -                        | -           | -           |
| 2590 x 2286 | 8676      | -                       | 1424                    | -                        | 1590                     | -                        | -                        | -           | -           |
| 2744 x 1981 | 9066      | -                       | 1491                    | -                        | 1509                     | -                        | -                        | -           | -           |
| 2744 x 2136 | 9070      | -                       | 1566                    | -                        | 1590                     | -                        | -                        | -           | -           |
| 2744 x 2286 | 9076      | -                       | 1626                    | -                        | 1649                     | -                        | -                        | -           | -           |
| 3049 x 1981 | 1066      | -                       | 1757                    | -                        | 1695                     | -                        | -                        | -           | -           |
| 3049 x 2136 | 1070      | -                       | 1779                    | -                        | 1714                     | -                        | -                        | -           | -           |

Stock doors also available in Jet Black (based on RAL 9005).

<sup>1</sup> Stock doors also available in Anthracite Grey (RAL 7016)

For further options please see page 15.

Single door

Nominal Door Size  
Width x Height  
(mm x mm)

Size  
Code

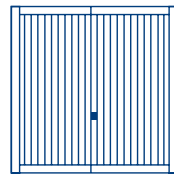

Sutton

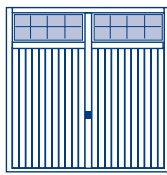

Salisbury <sup>1</sup>

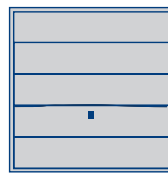

Wentwood  
Timber Effect

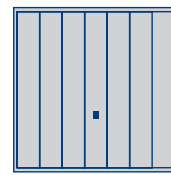

Sherwood  
Timber Effect

| Nominal Door Size<br>Width x Height<br>(mm x mm) | Size<br>Code | Sutton      |             | Salisbury <sup>1</sup>   |                          | Wentwood<br>Timber Effect |             | Sherwood<br>Timber Effect |             |
|--|--------------|-------------|-------------|--------------------------|--------------------------|---------------------------|-------------|---------------------------|-------------|
|  |              | C           | R           | C                        | R                        | C                         | R           | C                         | R           |
| 1984 x 1830                                      | 6660         | -           | -           | -                        | -                        | -                         | -           | -                         | -           |
| 1984 x 1905                                      | 6663         | -           | -           | -                        | -                        | -                         | -           | -                         | -           |
| 1984 x 1931                                      | 6664         | -           | -           | -                        | -                        | -                         | -           | -                         | -           |
| 1984 x 1981                                      | 6666         | -           | -           | -                        | -                        | -                         | -           | -                         | -           |
| 1984 x 2136                                      | 6670         | -           | -           | -                        | -                        | -                         | -           | -                         | -           |
| 2084 x 1931                                      | 61064        | -           | -           | -                        | -                        | -                         | -           | -                         | -           |
| 2084 x 1981                                      | 61066        | -           | -           | -                        | -                        | -                         | -           | -                         | -           |
| 2084 x 2136                                      | 61070        | -           | -           | -                        | -                        | -                         | -           | -                         | -           |
| 2134 x 1830                                      | 7060         | -           | -           | -                        | -                        | -                         | -           | -                         | -           |
| 2134 x 1905                                      | 7063         | -           | -           | -                        | -                        | -                         | -           | -                         | -           |
| 2134 x 1931                                      | 7064         | 1041        | 1090        | 1584                     | 1633                     | -                         | -           | -                         | -           |
| 2134 x 1981                                      | 7066         | 986         | 1035        | <b>1584</b>              | <b>1633</b>              | <b>1026</b>               | <b>1075</b> | <b>1190</b>               | <b>1239</b> |
| 2134 x 2036                                      | 7068         | -           | -           | 1669                     | 1718                     | -                         | -           | -                         | -           |
| 2134 x 2136                                      | 7070         | <b>1051</b> | <b>1100</b> | <b>1602</b>              | <b>1651</b>              | <b>1139</b>               | <b>1188</b> | <b>1225</b>               | <b>1274</b> |
| 2134 x 2186                                      | 7072         | -           | -           | -                        | 1744                     | -                         | -           | -                         | -           |
| 2134 x 2286                                      | 7076         | -           | -           | -                        | -                        | -                         | -           | -                         | -           |
| 2170 x 1931                                      | 7164         | -           | -           | 1584                     | 1633                     | -                         | -           | -                         | -           |
| 2170 x 1981                                      | 7166         | -           | -           | 1584                     | 1633                     | -                         | -           | -                         | -           |
| 2170 x 2036                                      | 7168         | -           | -           | 1669                     | 1718                     | -                         | -           | -                         | -           |
| 2170 x 2136                                      | 7170         | -           | -           | 1602                     | 1651                     | -                         | -           | -                         | -           |
| 2170 x 2186                                      | 7172         | -           | -           | -                        | 1744                     | -                         | -           | -                         | -           |
| 2170 x 2286                                      | 7176         | -           | -           | -                        | -                        | -                         | -           | -                         | -           |
| 2224 x 1931                                      | 7364         | -           | -           | 1647                     | 1696                     | -                         | -           | -                         | -           |
| 2224 x 1981                                      | 7366         | -           | -           | 1647                     | 1696                     | -                         | -           | -                         | -           |
| 2224 x 2136                                      | 7370         | -           | -           | 1663                     | 1712                     | -                         | -           | -                         | -           |
| 2259 x 1931                                      | 7564         | 1142        | 1191        | 1647                     | 1696                     | -                         | -           | -                         | -           |
| 2259 x 1981                                      | 7566         | 1142        | 1191        | 1647                     | 1696                     | -                         | -           | -                         | -           |
| 2259 x 2036                                      | 7568         | -           | -           | 1733                     | 1782                     | -                         | -           | -                         | -           |
| 2259 x 2136                                      | 7570         | 1258        | 1307        | 1663                     | 1712                     | -                         | -           | -                         | -           |
| 2259 x 2186                                      | 7572         | -           | -           | -                        | 1805                     | -                         | -           | -                         | -           |
| 2259 x 2286                                      | 7576         | -           | -           | -                        | -                        | -                         | -           | -                         | -           |
| 2284 x 1931                                      | 7664         | 1155        | 1204        | 1647                     | 1696                     | -                         | -           | -                         | -           |
| 2284 x 1981                                      | 7666         | 1097        | 1146        | 1647                     | 1696                     | <b>1166</b>               | <b>1215</b> | <b>1266</b>               | <b>1315</b> |
| 2284 x 2036                                      | 7668         | -           | -           | 1733                     | 1782                     | -                         | -           | -                         | -           |
| 2284 x 2136                                      | 7670         | 1211        | 1260        | <b>1663</b> <sup>2</sup> | <b>1712</b> <sup>2</sup> | <b>1298</b>               | <b>1347</b> | <b>1368</b>               | <b>1417</b> |
| 2284 x 2186                                      | 7672         | -           | -           | -                        | 1805                     | -                         | -           | -                         | -           |
| 2284 x 2286                                      | 7676         | -           | -           | -                        | -                        | -                         | -           | -                         | -           |
| 2439 x 1931                                      | 8064         | 1272        | 1321        | 1749                     | 1798                     | -                         | -           | -                         | -           |
| 2439 x 1981                                      | 8066         | 1272        | 1321        | 1749                     | 1798                     | <b>1290</b>               | <b>1339</b> | <b>1459</b>               | <b>1508</b> |
| 2439 x 2036                                      | 8068         | -           | -           | 1835                     | 1884                     | -                         | -           | -                         | -           |
| 2439 x 2136                                      | 8070         | 1295        | 1344        | <b>1764</b>              | <b>1813</b>              | <b>1336</b>               | <b>1385</b> | <b>1505</b>               | <b>1557</b> |
| 2439 x 2186                                      | 8072         | -           | -           | -                        | 1906                     | -                         | -           | -                         | -           |
| 2439 x 2286                                      | 8076         | -           | -           | -                        | -                        | -                         | -           | -                         | -           |
| 2590 x 1981                                      | 8666         | -           | -           | -                        | -                        | -                         | -           | -                         | -           |
| 2590 x 2136                                      | 8670         | -           | -           | -                        | -                        | -                         | -           | -                         | -           |
| 2590 x 2286                                      | 8676         | -           | -           | -                        | -                        | -                         | -           | -                         | -           |
| 2744 x 1981                                      | 9066         | -           | -           | -                        | -                        | -                         | -           | -                         | -           |
| 2744 x 2136                                      | 9070         | -           | -           | -                        | -                        | -                         | -           | -                         | -           |
| 2744 x 2286                                      | 9076         | -           | -           | -                        | -                        | -                         | -           | -                         | -           |
| 3049 x 1981                                      | 1066         | -           | -           | -                        | -                        | -                         | -           | -                         | -           |
| 3049 x 2136                                      | 1070         | -           | -           | -                        | -                        | -                         | -           | -                         | -           |

<sup>1</sup> Salisbury windows (with window icon) come as white as standard, colour match windows are available to order as an option, see page 15.

<sup>2</sup> Also available on 1 week lead time in Jet Black (RAL 9005) with black colour match windows.

Please note that doors with windows may have cross bracing or locking rods passing behind the windows depending upon size and gear type.

Stock doors also available in Jet Black (based on RAL 9005).

Wentwood and Sherwood models are only available in either a Golden Oak or Rosewood foil coat timber effect finish.

For further options please see page 15.



Single door

Nominal Door Size  
Width x Height  
(mm x mm)

Size  
Code

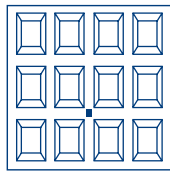

Georgian

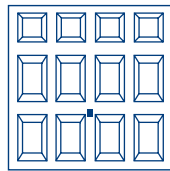

Beaumont

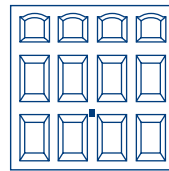

Cathedral

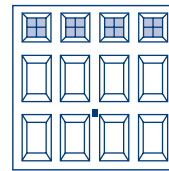

Beaumont with  
Windows<sup>1</sup>

| Nominal Door Size<br>Width x Height<br>(mm x mm) | Size<br>Code | Georgian    |             | Beaumont    |             | Cathedral   |             | Beaumont with<br>Windows <sup>1</sup> |             |
|--|--------------|-------------|-------------|-------------|-------------|-------------|-------------|---------------------------------------|-------------|
|  |              | C           | R           | C           | R           | C           | R           | C                                     | R           |
| 1984 x 1830                                      | 6660         | -           | -           | -           | -           | -           | -           | -                                     | -           |
| 1984 x 1905                                      | 6663         | -           | -           | -           | -           | -           | -           | -                                     | -           |
| 1984 x 1931                                      | 6664         | 1220        | 1269        | 1220        | 1269        | 1220        | 1269        | 1661                                  | 1710        |
| 1984 x 1981                                      | 6666         | 1156        | 1205        | 1156        | 1205        | 1156        | 1205        | 1667                                  | 1716        |
| 1984 x 2136                                      | 6670         | 1173        | 1222        | 1173        | 1222        | 1173        | 1222        | 1613                                  | 1662        |
| 2084 x 1931                                      | 61064        | 1169        | 1218        | 1169        | 1218        | 1169        | 1218        | 1609                                  | 1658        |
| 2084 x 1981                                      | 61066        | 1171        | 1220        | 1171        | 1220        | 1171        | 1220        | 1611                                  | 1660        |
| 2084 x 2136                                      | 61070        | 1256        | 1305        | 1256        | 1305        | 1256        | 1305        | 1694                                  | 1743        |
| 2134 x 1830                                      | 7060         | -           | -           | -           | -           | -           | -           | -                                     | -           |
| 2134 x 1905                                      | 7063         | -           | -           | -           | -           | -           | -           | -                                     | -           |
| 2134 x 1931                                      | 7064         | 1171        | 1220        | 1171        | 1220        | 1171        | 1220        | 1611                                  | 1660        |
| 2134 x 1981                                      | 7066         | <b>1171</b> | <b>1220</b> | <b>1171</b> | <b>1220</b> | <b>1171</b> | <b>1220</b> | <b>1611</b>                           | <b>1660</b> |
| 2134 x 2136                                      | 7070         | <b>1241</b> | <b>1290</b> | <b>1241</b> | <b>1290</b> | <b>1241</b> | <b>1290</b> | <b>1678</b>                           | <b>1727</b> |
| 2134 x 2286                                      | 7076         | -           | 1476        | -           | 1476        | -           | 1476        | -                                     | 1913        |
| 2170 x 1931                                      | 7164         | 1171        | 1220        | 1171        | 1220        | 1171        | 1220        | 1611                                  | 1660        |
| 2170 x 1981                                      | 7166         | 1171        | 1220        | 1171        | 1220        | 1171        | 1220        | 1611                                  | 1660        |
| 2170 x 2136                                      | 7170         | 1241        | 1290        | 1241        | 1290        | 1241        | 1290        | 1678                                  | 1727        |
| 2170 x 2286                                      | 7176         | -           | 1595        | -           | 1595        | -           | 1595        | -                                     | 2035        |
| 2224 x 1931                                      | 7364         | 1301        | 1350        | 1301        | 1350        | 1301        | 1350        | 1744                                  | 1793        |
| 2224 x 1981                                      | 7366         | 1308        | 1357        | 1308        | 1357        | 1308        | 1357        | 1750                                  | 1799        |
| 2224 x 2136                                      | 7370         | 1316        | 1365        | 1316        | 1365        | 1316        | 1365        | 1757                                  | 1806        |
| 2259 x 1931                                      | 7564         | 1301        | 1350        | 1301        | 1350        | 1301        | 1350        | 1744                                  | 1793        |
| 2259 x 1981                                      | 7566         | 1301        | 1350        | 1301        | 1350        | 1301        | 1350        | 1744                                  | 1793        |
| 2259 x 2136                                      | 7570         | 1497        | 1546        | 1497        | 1546        | 1497        | 1546        | 1942                                  | 1991        |
| 2259 x 2286                                      | 7576         | -           | 1818        | -           | 1818        | -           | 1818        | -                                     | 2257        |
| 2284 x 1931                                      | 7664         | 1301        | 1350        | 1301        | 1350        | 1301        | 1350        | 1744                                  | 1793        |
| 2284 x 1981                                      | 7666         | <b>1301</b> | <b>1350</b> | 1301        | 1350        | 1301        | 1350        | 1744                                  | 1793        |
| 2284 x 2136                                      | 7670         | <b>1497</b> | <b>1546</b> | <b>1497</b> | <b>1546</b> | 1497        | 1546        | <b>1942</b>                           | <b>1991</b> |
| 2284 x 2286                                      | 7676         | -           | 1818        | -           | 1818        | -           | 1818        | -                                     | 2257        |
| 2439 x 1931                                      | 8064         | 1540        | 1589        | 1540        | 1589        | 1540        | 1589        | 1981                                  | 2030        |
| 2439 x 1981                                      | 8066         | <b>1540</b> | <b>1589</b> | 1540        | 1589        | 1540        | 1589        | 1981                                  | 2030        |
| 2439 x 2136                                      | 8070         | 1605        | 1654        | 1605        | 1654        | 1605        | 1654        | 2044                                  | 2093        |
| 2439 x 2286                                      | 8076         | -           | 1783        | -           | 1783        | -           | 1783        | -                                     | 2294        |
| 2590 x 1981                                      | 8666         | -           | 1643        | -           | 1643        | -           | 1643        | -                                     | 2151        |
| 2590 x 2136                                      | 8670         | -           | 1662        | -           | 1662        | -           | 1662        | -                                     | 2173        |
| 2590 x 2286                                      | 8676         | -           | 1841        | -           | 1841        | -           | 1841        | -                                     | 2348        |
| 2744 x 1981                                      | 9066         | -           | 1667        | -           | 1667        | -           | 1667        | -                                     | 2180        |
| 2744 x 2136                                      | 9070         | -           | 1690        | -           | 1690        | -           | 1690        | -                                     | 2198        |
| 2744 x 2286                                      | 9076         | -           | 1866        | -           | 1866        | -           | 1866        | -                                     | 2378        |
| 3049 x 1981                                      | 1066         | -           | 1730        | -           | 1730        | -           | 1730        | -                                     | 2243        |
| 3049 x 2136                                      | 1070         | -           | 1766        | -           | 1766        | -           | 1766        | -                                     | 2281        |

<sup>1</sup> Windows for Beaumont: Standard (□), Diamond (◊), Cross (⊕). Please state on order if clear or crystal panes, see page 15.

Please note that doors with windows may have cross bracing or locking rods passing behind the windows depending upon size and gear type.

Stock doors also available in Jet Black (based on RAL 9005).

For further options please see page 15.

Single door

Nominal Door Size  
Width x Height  
(mm x mm)

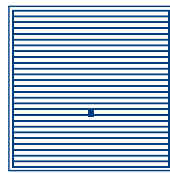

Horizon

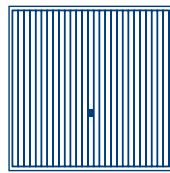

Carlton

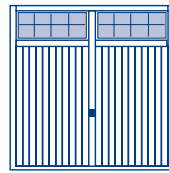

Salisbury

|                        |             | Horizon |      | Carlton |      | Salisbury |      |
|------------------------|-------------|---------|------|---------|------|-----------|------|
|                        |             | C       | R    | C       | R    | C         | R    |
| 1830-1930              | x 1830-1930 | 1162    | 1211 | 1206    | 1255 | -         | -    |
| 1830-1930              | x 1931-1981 | 1205    | 1254 | 1250    | 1299 | -         | -    |
| 1830-1930              | x 1982-2136 | 1296    | 1345 | 1323    | 1372 | -         | -    |
| 1830-1930              | x 2137-2286 | -       | 1458 | -       | 1507 | -         | -    |
| 1830-1930              | x 2287-2439 | -       | -    | -       | 1605 | -         | -    |
| 1931-1984              | x 1830-1930 | 1169    | 1218 | 1220    | 1269 | -         | -    |
| 1931-1984              | x 1931-1981 | 1213    | 1262 | 1261    | 1310 | -         | -    |
| 1931-1984              | x 1982-2136 | 1287    | 1336 | 1328    | 1377 | -         | -    |
| 1931-1984              | x 2137-2286 | -       | 1458 | -       | 1507 | -         | -    |
| 1931-1984              | x 2287-2439 | -       | 1564 | -       | 1605 | -         | -    |
| 1985-2134              | x 1830-1930 | 1213    | 1262 | 1259    | 1308 | -         | -    |
| 1985-2134              | x 1931-1981 | 1287    | 1336 | 1328    | 1377 | -         | -    |
| 1985-2134              | x 1982-2136 | 1389    | 1438 | 1415    | 1464 | -         | -    |
| 1985-2134              | x 2137-2286 | -       | 1564 | -       | 1605 | -         | -    |
| 1985-2134              | x 2287-2439 | -       | 1662 | -       | 1692 | -         | -    |
| 2135-2284              | x 1830-1930 | 1287    | 1336 | 1312    | 1361 | -         | -    |
| 2135-2284              | x 1931-1981 | 1389    | 1438 | 1415    | 1464 | -         | -    |
| 2135-2284              | x 1982-2136 | 1476    | 1525 | 1523    | 1572 | 1900      | 2147 |
| 2135-2284              | x 2137-2286 | -       | 1662 | -       | 1692 | -         | -    |
| 2135-2284              | x 2287-2439 | -       | 1765 | -       | 1809 | -         | -    |
| 2285-2499 <sup>1</sup> | x 1830-1930 | 1389    | 1438 | 1430    | 1479 | -         | -    |
| 2285-2499 <sup>1</sup> | x 1931-1981 | 1476    | 1525 | 1523    | 1572 | -         | -    |
| 2285-2499 <sup>1</sup> | x 1982-2136 | 1487    | 1536 | 1605    | 1654 | 2098      | 2147 |
| 2285-2499              | x 2137-2286 | -       | 1695 | -       | 1730 | -         | -    |
| 2285-2499              | x 2287-2439 | -       | 1766 | -       | 1784 | -         | -    |
| 2500-2590              | x 1830-1930 | -       | 1590 | -       | 1618 | -         | -    |
| 2500-2590              | x 1931-1981 | -       | 1662 | -       | 1692 | -         | -    |
| 2500-2590              | x 1982-2136 | -       | 1766 | -       | 1766 | -         | -    |
| 2500-2590              | x 2137-2286 | -       | 1784 | -       | 1784 | -         | -    |
| 2500-2590              | x 2287-2439 | -       | 1893 | -       | 1893 | -         | -    |
| 2591-2722              | x 1830-1930 | -       | 1690 | -       | 1690 | -         | -    |
| 2591-2722              | x 1931-1981 | -       | 1757 | -       | 1757 | -         | -    |
| 2591-2722              | x 1982-2136 | -       | 1879 | -       | 1879 | -         | -    |
| 2591-2722              | x 2137-2286 | -       | 1997 | -       | 1997 | -         | -    |
| 2591-2722              | x 2287-2439 | -       | 2129 | -       | 2129 | -         | -    |
| 2723-3049              | x 1830-1930 | -       | -    | -       | 2056 | -         | -    |
| 2723-3049              | x 1931-1981 | -       | -    | -       | 2128 | -         | -    |
| 2723-3049              | x 1982-2136 | -       | -    | -       | 2344 | -         | -    |

<sup>1</sup> Canopy gear only available up to 2439 wide.

Orders for purpose made sizes will only be accepted as nominal door size for unframed version and overall frame size when ordering a framed version. Orders for purpose made framed doors will not be accepted as nominal door size.

For further options please see page 15.

Single door

Nominal Door Size  
Width x Height  
(mm x mm)

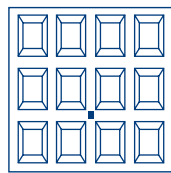

Georgian

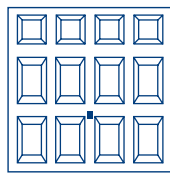

Beaumont

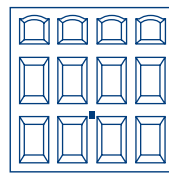

Cathedral

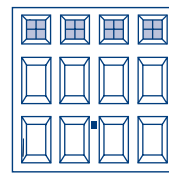

Beaumont with Windows<sup>2</sup>

|                        |             | Georgian |      | Beaumont |      | Cathedral |      | Beaumont with Windows <sup>2</sup> |      |
|------------------------|-------------|----------|------|----------|------|-----------|------|------------------------------------|------|
|                        |             | C        | R    | C        | R    | C         | R    | C                                  | R    |
| 1830-1930              | x 1830-1930 | -        | -    | -        | -    | -         | -    | -                                  | -    |
| 1830-1930              | x 1931-1981 | -        | -    | -        | -    | -         | -    | -                                  | -    |
| 1830-1930              | x 1982-2136 | -        | -    | -        | -    | -         | -    | -                                  | -    |
| 1830-1930              | x 2137-2286 | -        | -    | -        | -    | -         | -    | -                                  | -    |
| 1830-1930              | x 2287-2439 | -        | -    | -        | -    | -         | -    | -                                  | -    |
| 1931-1984              | x 1830-1930 | -        | -    | -        | -    | -         | -    | -                                  | -    |
| 1931-1984              | x 1931-1981 | -        | -    | -        | -    | -         | -    | -                                  | -    |
| 1931-1984              | x 1982-2136 | -        | -    | -        | -    | -         | -    | -                                  | -    |
| 1931-1984              | x 2137-2286 | -        | -    | -        | -    | -         | -    | -                                  | -    |
| 1931-1984              | x 2287-2439 | -        | -    | -        | -    | -         | -    | -                                  | -    |
| 1985-2134              | x 1830-1930 | -        | -    | -        | -    | -         | -    | -                                  | -    |
| 1985-2134              | x 1931-1981 | 1829     | 1878 | 1829     | 1878 | 1829      | 1878 | 2268                               | 2317 |
| 1985-2134              | x 1982-2136 | 1943     | 1992 | 1943     | 1992 | 1943      | 1992 | 2383                               | 2432 |
| 1985-2134              | x 2137-2286 | -        | 2134 | -        | 2134 | -         | 2134 | -                                  | 2574 |
| 1985-2134              | x 2287-2439 | -        | 2058 | -        | 2058 | -         | 2058 | -                                  | 2498 |
| 2135-2284              | x 1830-1930 | -        | -    | -        | -    | -         | -    | -                                  | -    |
| 2135-2284              | x 1931-1981 | 1959     | 2008 | 1959     | 2008 | 1959      | 2008 | 2401                               | 2450 |
| 2135-2284              | x 1982-2136 | 1959     | 2008 | 1959     | 2008 | 1959      | 2008 | 2401                               | 2450 |
| 2135-2284              | x 2137-2286 | -        | 2114 | -        | 2114 | -         | 2114 | -                                  | 2557 |
| 2135-2284              | x 2287-2439 | -        | 2407 | -        | 2407 | -         | 2407 | -                                  | 2847 |
| 2285-2499 <sup>1</sup> | x 1830-1930 | -        | -    | -        | -    | -         | -    | -                                  | -    |
| 2285-2499 <sup>1</sup> | x 1931-1981 | 2078     | 2127 | 2078     | 2127 | 2078      | 2127 | 2522                               | 2571 |
| 2285-2499 <sup>1</sup> | x 1982-2136 | 2113     | 2162 | 2113     | 2162 | 2113      | 2162 | 2556                               | 2605 |
| 2285-2499              | x 2137-2286 | -        | 2249 | -        | 2249 | -         | 2249 | -                                  | 2690 |
| 2285-2499              | x 2287-2439 | -        | 2340 | -        | 2340 | -         | 2340 | -                                  | 2780 |
| 2500-2590              | x 1830-1930 | -        | -    | -        | -    | -         | -    | -                                  | -    |
| 2500-2590              | x 1931-1981 | -        | 2230 | -        | 2230 | -         | 2230 | -                                  | 2671 |
| 2500-2590              | x 1982-2136 | -        | 2265 | -        | 2265 | -         | 2265 | -                                  | 2708 |
| 2500-2590              | x 2137-2286 | -        | 2317 | -        | 2317 | -         | 2317 | -                                  | 2759 |
| 2500-2590              | x 2287-2439 | -        | 2393 | -        | 2393 | -         | 2393 | -                                  | 2830 |
| 2591-2722              | x 1830-1930 | -        | -    | -        | -    | -         | -    | -                                  | -    |
| 2591-2722              | x 1931-1981 | -        | 2239 | -        | 2239 | -         | 2239 | -                                  | 2680 |
| 2591-2722              | x 1982-2136 | -        | 2345 | -        | 2345 | -         | 2345 | -                                  | 2790 |
| 2591-2722              | x 2137-2286 | -        | 2416 | -        | 2416 | -         | 2416 | -                                  | 2859 |
| 2591-2722              | x 2287-2439 | -        | -    | -        | -    | -         | -    | -                                  | -    |
| 2723-3049              | x 1830-1930 | -        | -    | -        | -    | -         | -    | -                                  | -    |
| 2723-3049              | x 1931-1981 | -        | 2393 | -        | 2393 | -         | 2393 | -                                  | 2830 |
| 2723-3049              | x 1982-2136 | -        | 2482 | -        | 2482 | -         | 2482 | -                                  | 2922 |

<sup>1</sup> Canopy gear only available up to 2439 wide.

<sup>2</sup> Windows for Beaumont: Standard (□), Diamond (◊), Cross (⊕). Please state on order if clear or crystal panes.

Orders for purpose made sizes will only be accepted as nominal door size for unframed version and overall frame size when ordering a framed version. Orders for purpose made framed doors will not be accepted as nominal door size.

Please note that doors with windows may have cross bracing or locking rods passing behind the windows depending upon size and gear type.

For further options please see page 15.

Double door

Nominal Door Size  
Width x Height  
(mm x mm)

Size  
Code

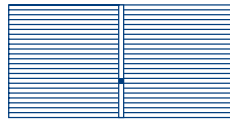

Horizon

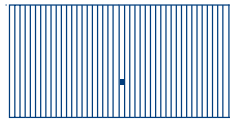

Carlton

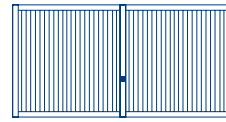

Sutton

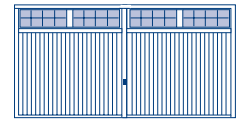

Salisbury

|             |      | R           | R           | R    | R           |
|-------------|------|-------------|-------------|------|-------------|
| 3049 x 2286 | 1076 | 2275        | 2275        | -    | -           |
| 3354 x 1981 | 1166 | 2128        | 2128        | -    | -           |
| 3354 x 2136 | 1170 | 2144        | 2144        | -    | -           |
| 3354 x 2286 | 1176 | 2199        | 2199        | -    | -           |
| 3659 x 1981 | 1266 | 2234        | 2234        | -    | -           |
| 3659 x 2136 | 1270 | 2251        | 2251        | -    | -           |
| 3659 x 2286 | 1276 | 2410        | 2410        | -    | -           |
| 3964 x 1981 | 1366 | 2431        | 2431        | -    | -           |
| 3964 x 2136 | 1370 | 2449        | 2449        | -    | -           |
| 3964 x 2286 | 1376 | 2683        | 2683        | -    | -           |
| 4269 x 1981 | 1466 | <b>2342</b> | <b>2342</b> | 2533 | 3242        |
| 4268 x 2036 | 1468 | -           | <b>2342</b> | -    | -           |
| 4269 x 2136 | 1470 | <b>2342</b> | <b>2342</b> | 2533 | <b>3242</b> |
| 4268 x 2186 | 1472 | -           | <b>2342</b> | -    | -           |
| 4574 x 1981 | 1566 | 2522        | 2522        | 2713 | -           |
| 4574 x 2136 | 1570 | 2559        | 2559        | 2750 | -           |
| 4879 x 1981 | 1666 | 2667        | 2667        | 2858 | -           |
| 4879 x 2136 | 1670 | 2701        | 2701        | 2892 | -           |

Double door

Nominal Door Size  
Width x Height  
(mm x mm)

Size  
Code

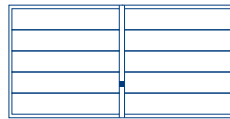

Ascot

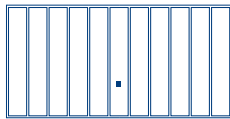

Windsor

|             |      | R    | R    |
|-------------|------|------|------|
| 3049 x 2286 | 1076 | -    | -    |
| 3354 x 1981 | 1166 | -    | -    |
| 3354 x 2136 | 1170 | -    | -    |
| 3354 x 2286 | 1176 | -    | -    |
| 3659 x 1981 | 1266 | -    | -    |
| 3659 x 2136 | 1270 | -    | -    |
| 3659 x 2286 | 1276 | -    | -    |
| 3964 x 1981 | 1366 | -    | -    |
| 3964 x 2136 | 1370 | -    | -    |
| 3964 x 2286 | 1376 | -    | -    |
| 4269 x 1981 | 1466 | 2476 | 2476 |
| 4269 x 2136 | 1470 | 2476 | 2476 |
| 4574 x 1981 | 1566 | -    | -    |
| 4574 x 2136 | 1570 | -    | -    |
| 4879 x 1981 | 1666 | -    | -    |
| 4879 x 2136 | 1670 | -    | -    |

Please note that doors with windows may have cross bracing or locking rods passing behind the windows depending upon size and gear type.

For further options please see page 15.

Double door

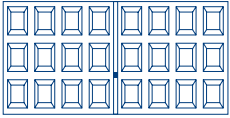
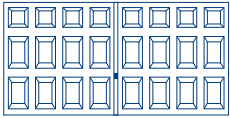
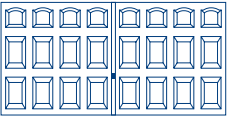
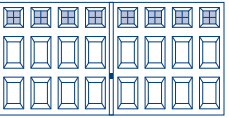
| Nominal Door Size<br>Width x Height<br>(mm x mm) | Size<br>Code |  |  |  |  |
|--|--------------|---|---|--|---|
|  |              | Georgian  | Beaumont  | Cathedral  | Beaumont with Windows <sup>1</sup>  |
|  |              | R   | R   | R  | R   |
| 3049 x 2286                                      | 1076         | 2275  | 2275  | 2275   | 2931  |
| 3354 x 1981                                      | 1166         | 2234  | 2234  | 2234   | 2898  |
| 3354 x 2136                                      | 1170         | 2234  | 2234  | 2234   | 2898  |
| 3354 x 2286                                      | 1176         | 2414  | 2414  | 2414   | 3076  |
| 3659 x 1981                                      | 1266         | 2379  | 2379  | 2379   | 3040  |
| 3659 x 2136                                      | 1270         | 2379  | 2379  | 2379   | 3040  |
| 3659 x 2286                                      | 1276         | 2488  | 2488  | 2488   | 3148  |
| 3964 x 1981                                      | 1366         | 2450  | 2450  | 2450   | 3111  |
| 3964 x 2136                                      | 1370         | 2450  | 2450  | 2450   | 3111  |
| 3964 x 2286                                      | 1376         | 2488  | 2488  | 2488   | 3162  |
| 4269 x 1981                                      | 1466         | 2522  | 2522  | 2522   | 3181  |
| 4269 x 2136                                      | 1470         | <b>2522</b>   | <b>2522</b>   | <b>2522</b>  | 3181  |
| 4574 x 1981                                      | 1566         | 2739  | 2739  | 2739   | 3398  |
| 4574 x 2136                                      | 1570         | 2739  | 2739  | 2739   | 3398  |
| 4879 x 1981                                      | 1666         | 2881  | 2881  | 2881   | 3545  |
| 4879 x 2136                                      | 1670         | 2881  | 2881  | 2881   | 3545  |

<sup>1</sup> Windows for Beaumont: Standard () , Diamond () , Cross () . Please state on order if clear or crystal panes.

Please note that doors with windows may have cross bracing or locking rods passing behind the windows depending upon size and gear type.

For further options please see page 15.

### Double door

Nominal Door Size  
Width x Height  
(mm x mm)

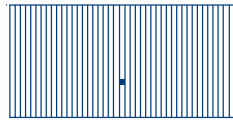

Carlton

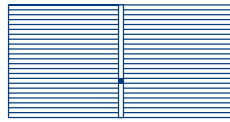

Horizon

|                       | R    | R    |
|-----------------------|------|------|
| 2745-3049 x 2137-2286 | 2630 | -    |
| 3050-3354 x 1886-1981 | 2488 | 2522 |
| 3050-3354 x 1982-2136 | 2506 | 2540 |
| 3050-3354 x 2137-2286 | 2739 | 2774 |
| 3355-3659 x 1886-1981 | 2559 | 2594 |
| 3355-3659 x 1982-2136 | 2612 | 2647 |
| 3355-3659 x 2137-2286 | 2739 | 2774 |
| 3660-3967 x 1886-1981 | 2792 | 2828 |
| 3660-3967 x 1982-2136 | 2845 | 2881 |
| 3660-3967 x 2137-2286 | 3045 | 3078 |
| 3968-4269 x 1886-1981 | 2701 | 2739 |
| 3968-4269 x 1982-2136 | 2739 | 2774 |
| 4270-5000 x 1886-1981 | 2992 | 3024 |
| 4270-5000 x 1982-2136 | 3062 | 3098 |

### Double door

Nominal Door Size  
Width x Height  
(mm x mm)

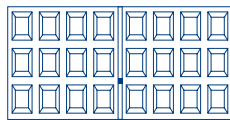

Georgian

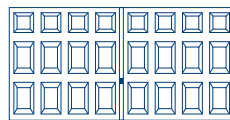

Beaumont

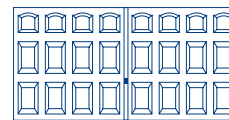

Cathedral

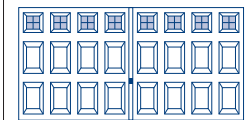

Beaumont with Windows <sup>1</sup>

|                       | R    | R    | R    | R    |
|-----------------------|------|------|------|------|
| 2745-3049 x 2137-2286 | 2630 | 2630 | 2630 | 3083 |
| 3050-3354 x 1931-1981 | 2594 | 2594 | 2594 | 3257 |
| 3050-3354 x 1982-2136 | 2630 | 2630 | 2630 | 3293 |
| 3050-3354 x 2137-2286 | 2774 | 2774 | 2774 | 3439 |
| 3355-3659 x 1931-1981 | 2739 | 2739 | 2739 | 3398 |
| 3355-3659 x 1982-2136 | 2810 | 2810 | 2810 | 3472 |
| 3355-3659 x 2137-2286 | 2845 | 2845 | 2845 | 3508 |
| 3660-3967 x 1931-1981 | 2810 | 2810 | 2810 | 3688 |
| 3660-3967 x 1982-2136 | 2845 | 2845 | 2845 | 3726 |
| 3660-3967 x 2137-2286 | 2881 | 2881 | 2881 | 3763 |
| 3968-4269 x 1931-1981 | 2881 | 2881 | 2881 | 3763 |
| 3968-4269 x 1982-2136 | 2881 | 2881 | 2881 | 3763 |
| 4270-5000 x 1931-1981 | 3242 | 3242 | 3242 | 4342 |
| 4270-5000 x 1982-2136 | 3242 | 3242 | 3242 | 4342 |

<sup>1</sup> Windows for Beaumont: Standard (□), Diamond (◊), Cross (⊕). Please state on order if clear or crystal panes.

Orders for purpose made sizes will only be accepted as nominal door size for unframed version and overall frame size when ordering a framed version. Orders for purpose made framed doors will not be accepted as nominal door size.

Please note that doors with windows may have cross bracing or locking rods passing behind the windows depending upon size and gear type. For further options please see page 15.

| Options  | Single doors | Double doors |
|--|--------------|--------------|
|  | add          | add          |
| Factory pre-framed standard single doors   | 178          | -            |
| Steel frame for standard double doors  | -            | 267          |
| Factory pre-framed purpose-made single doors<br>(framed retractable purpose made doors require a 4 week lead-time)   | 201          | -            |
| Steel frame for purpose made double doors  | -            | 297          |
| Additional Lock Kit, C-type/ R-type (fitted onto door)   | 83           | -            |
| Retractable plus gear available on 1931, 1981 and 2136 mm high doors<br>up to 2744 mm wide   | 85           | -            |
| For powder-coated doors <sup>1</sup> : Moss Green (RAL 6005), Ruby Red (RAL 3003),<br>Signal Blue (RAL 5005), Jet Black (RAL 9005), Steel Blue (RAL 5011),<br>Light Ivory (RAL 1015), Pigeon Blue (RAL 5014), Fir Green (RAL 6009),<br>Anthracite Grey (RAL 7016), Stone Grey (RAL 7030), Light Grey (RAL 7035),<br>Slate Grey (RAL 7015), Agate Grey (RAL 7038), Window Grey (RAL 7040),<br>Chartwell Green (BS 4800), Burgundy Brown <sup>2</sup> , Golden Brown <sup>2</sup> and<br>Terra Brown (RAL 8028). | 176          | 275          |
| Coloured window frames to match door colour – Beaumont doors (price per window).<br>Beaumont doors up to 3049 wide = 4 windows, between 3050 to 3964 = 6 windows,<br>between 3965 to 4860 = 8 windows and over 4860 = 10 windows <sup>2</sup> .  | 65 each      | 65 each      |
| Coloured window frames to match door colour – Salisbury doors (price per door) <sup>2</sup>  | 221          | 434          |
| Black window panes for Salisbury doors (price per door)  | 50           | 94           |
| Poly-wrapping  | 47           | 86           |
| Diecast metal handles: brass effect, chrome effect, brushed steel and white  | 98           | 98           |
| Bottom weatherseal, 2405 mm length (suitable for gaps up to 15 mm between the door<br>and the floor level)   | 61           | 61           |
| Bottom weatherseal, 3000 mm length (suitable for gaps up to 15 mm between the door<br>and the floor level)   | 67           | 67           |
| Surcharge on White RAL 9016 doors for colour steel frame in RAL colour not matching<br>Garage door   | 176          | 275          |

<sup>1</sup> Please state coloured windows required on order. Coloured Beaumont with windows and Salisbury doors are supplied with white window frames as standard.

<sup>2</sup> Colour match windows not available in Burgundy Brown or Golden Brown.

Please note that doors with windows may have cross bracing or locking rods passing behind the windows depending upon size and gear type.

# Guardian Range

## New Secured By Design certified Up & Over doors

These doors have been tested to the STS 202 Security Technical Specification and achieve Secured By Design accreditation. New lock body protection, anti-snap cylinder, high security bracing and improved lock security make these doors even more secure.

### Information

Guardian Range doors come with a pre-fitted steel frame and cannot be fitted to a custom made timber frame.

There is no mechanism to unlock Guardian range doors from the inside.

Guardian Range doors are not suitable for automation. Only available with canopy or retractable lifting gear.

Retractable plus not available.

Window panes on Secured by Design Salisbury doors are black non-translucent.

### Single door - standard sizes

Nominal Door Size  
Width x Height  
(mm x mm)

Size  
Code

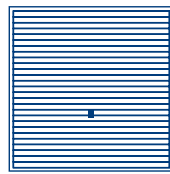

Horizon

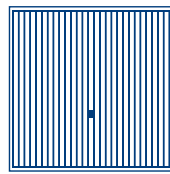

Carlton

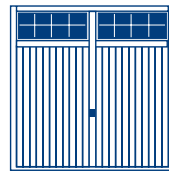

Salisbury

| Nominal Door Size<br>Width x Height<br>(mm x mm) | Size<br>Code | Horizon |      | Carlton |      | Salisbury |      |
|--|--------------|---------|------|---------|------|-----------|------|
|  |              | C       | R    | C       | R    | C         | R    |
| 1984 x 1830                                      | 6660         | 1483    | 1532 | 1606    | 1655 | -         | -    |
| 1984 x 1905                                      | 6663         | 1483    | 1532 | 1606    | 1655 | -         | -    |
| 1984 x 1931                                      | 6664         | 1483    | 1532 | 1606    | 1655 | -         | -    |
| 1984 x 1981                                      | 6666         | 1442    | 1491 | 1557    | 1606 | -         | -    |
| 1984 x 2136                                      | 6670         | 1458    | 1507 | 1557    | 1606 | -         | -    |
| 2084 x 1931                                      | 61064        | 1458    | 1507 | 1557    | 1606 | -         | -    |
| 2084 x 1981                                      | 61066        | 1478    | 1527 | 1557    | 1606 | -         | -    |
| 2084 x 2136                                      | 61070        | 1509    | 1558 | 1573    | 1622 | -         | -    |
| 2134 x 1830                                      | 7060         | 1511    | 1560 | 1630    | 1679 | -         | -    |
| 2134 x 1905                                      | 7063         | 1511    | 1560 | 1630    | 1679 | -         | -    |
| 2134 x 1931                                      | 7064         | 1465    | 1514 | 1560    | 1609 | 2193      | 2242 |
| 2134 x 1981                                      | 7066         | 1368    | 1417 | 1528    | 1577 | 2193      | 2242 |
| 2134 x 2031                                      | 7068         | 1549    | 1598 | 1647    | 1696 | -         | -    |
| 2134 x 2136                                      | 7070         | 1479    | 1528 | 1567    | 1616 | 2209      | 2258 |
| 2134 x 2186                                      | 7072         | -       | 1630 | -       | 1725 | -         | -    |
| 2170 x 1931                                      | 7164         | 1549    | 1598 | 1625    | 1674 | -         | -    |
| 2170 x 1981                                      | 7166         | 1368    | 1417 | 1528    | 1577 | -         | -    |
| 2170 x 2036                                      | 7168         | 1549    | 1598 | 1647    | 1696 | -         | -    |
| 2170 x 2136                                      | 7170         | 1573    | 1622 | 1675    | 1724 | -         | -    |
| 2170 x 2186                                      | 7172         | -       | 1642 | -       | 1743 | -         | -    |
| 2224 x 1931                                      | 7364         | 1541    | 1590 | 1605    | 1654 | -         | -    |
| 2224 x 1981                                      | 7366         | 1549    | 1598 | 1609    | 1658 | -         | -    |
| 2224 x 2136                                      | 7370         | 1563    | 1612 | 1621    | 1670 | -         | -    |
| 2259 x 1931                                      | 7564         | 1591    | 1640 | 1658    | 1707 | 2252      | 2301 |
| 2259 x 1981                                      | 7566         | 1541    | 1590 | 1613    | 1662 | 2252      | 2301 |
| 2259 x 2036                                      | 7568         | 1673    | 1722 | 1741    | 1790 | -         | -    |
| 2259 x 2136                                      | 7570         | 1673    | 1722 | 1741    | 1790 | 2268      | 2317 |
| 2259 x 2286                                      | 7572         | -       | 1741 | -       | 1810 | -         | -    |
| 2284 x 1931                                      | 7664         | 1541    | 1590 | 1642    | 1691 | 2252      | 2301 |
| 2284 x 1981                                      | 7666         | 1541    | 1590 | 1642    | 1691 | 2252      | 2301 |
| 2284 x 2031                                      | 7668         | 1629    | 1678 | 1734    | 1783 | -         | -    |
| 2284 x 2136                                      | 7670         | 1675    | 1724 | 1741    | 1790 | 2268      | 2317 |
| 2284 x 2186                                      | 7672         | -       | -    | -       | 1907 | -         | -    |
| 2439 x 1931                                      | 8064         | -       | -    | -       | 1901 | -         | 2423 |
| 2439 x 1981                                      | 8066         | -       | -    | -       | 1901 | -         | 2423 |
| 2439 x 2031                                      | 8068         | -       | -    | -       | 2008 | -         | -    |
| 2439 x 2136                                      | 8070         | -       | -    | -       | 1943 | -         | 2443 |
| 2439 x 2186                                      | 8072         | -       | -    | -       | 2052 | -         | -    |
| 2590 x 1981                                      | 8666         | -       | -    | -       | 2010 | -         | -    |
| 2590 x 2136                                      | 8670         | -       | -    | -       | 2069 | -         | -    |
| 2744 x 1981                                      | 9066         | -       | -    | -       | 2111 | -         | -    |
| 2744 x 2136                                      | 9070         | -       | -    | -       | 2194 | -         | -    |

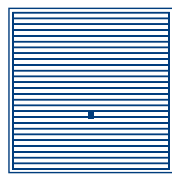

**Single door -  
purpose-made sizes**Nominal Door Size  
Width x Height  
(mm x mm)

Horizon

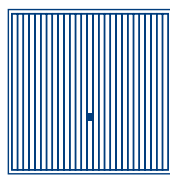

Carlton

|           |             | Horizon |      | Carlton |      |
|-----------|-------------|---------|------|---------|------|
|           |             | C       | R    | C       | R    |
| 1985-2134 | x 1830-1930 | 1819    | 1868 | 1864    | 1913 |
| 1985-2134 | x 1931-1981 | 1891    | 1940 | 1940    | 1989 |
| 1985-2134 | x 1982-2136 | 1997    | 2046 | 2022    | 2071 |
| 2135-2284 | x 1830-1930 | 1891    | 1940 | 1919    | 1968 |
| 2135-2284 | x 1931-1981 | 1997    | 2046 | 1997    | 2046 |
| 2135-2284 | x 1982-2136 | 2079    | 2128 | 2127    | 2176 |
| 2285-2499 | x 1830-1930 | -       | -    | -       | 2073 |
| 2285-2499 | x 1931-1981 | -       | -    | -       | 2158 |
| 2285-2499 | x 1982-2136 | -       | -    | -       | 2238 |
| 2500-2590 | x 1830-1930 | -       | -    | -       | 2184 |
| 2500-2590 | x 1931-1981 | -       | -    | -       | 2251 |
| 2500-2590 | x 1982-2136 | -       | -    | -       | 2327 |
| 2591-2722 | x 1830-1930 | -       | -    | -       | 2249 |
| 2591-2722 | x 1931-1981 | -       | -    | -       | 2315 |
| 2591-2722 | x 1982-2136 | -       | -    | -       | 2434 |

Orders for purpose made sizes will only be accepted as overall frame size when ordering a framed version. Orders for purpose made framed doors will not be accepted as nominal door size.

**Options for single doors**

add

For powder coated doors: Moss Green (RAL 6005), Ruby Red (RAL 3003), Signal Blue (RAL 5005), Jet Black (RAL 9005), Steel Blue (RAL 5011), Light Ivory (RAL 1015), Pigeon Blue (RAL 5014), Fir Green (RAL 6009), Anthracite Grey (RAL 7016), Stone Grey (RAL 7030), Light Grey (RAL 7035), Slate Grey (RAL 7015), Agate Grey (RAL 7038), Window Grey (RAL 7040), Chartwell Green (BS 4800), Burgundy Brown<sup>2</sup>, Golden Brown<sup>2</sup> and Terra Brown (RAL 8028).

176

Coloured window frames on Salisbury to match door colour<sup>1</sup>

221

Poly-wrapping

47

<sup>1</sup> Colour match windows not available in Burgundy Brown or Golden Brown.



Secured by Design is an association focusing on the design of more secure homes and commercial properties.

Secured by Design is owned by the ACPO (Association of Chief Police Officers) and awards the Secured by Design status to products that pass their extensive testing procedures.

# Design Range

## Surface and finish

The Series 100 Design Range skins are built from four horizontal skins, whilst the Series 200 range is constructed from three vertical skins. Stainless steel elements on Garador design range doors are manufactured from high grade 2 mm thick steel with a brushed finish. The series 100 and 200 design range doors are also available without stainless steel elements. On Design Range doors a choice of any standard colour comes free of charge, please see page 19 for a choice of the 19 standard RAL colours available.

Please note: panel doors are produced with appearance in mind. This may result in some small gaps which could allow water ingress especially in exposed locations.

## Handle

A new perfectly matched handle offers a quality feel everytime you open the door.

## Terminology

**Nominal Door Size:** This is the actual door panel size plus the fitting tolerances. The nominal door size should be used for internal dimensions of a timber frame.

**Size Code:** This has traditionally been used to order doors. This may not be the actual door size.

### Single door

Nominal Door Size  
Width x Height  
(mm x mm)

Size  
Code

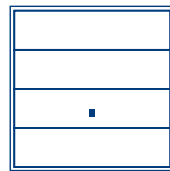

100

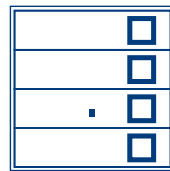

101

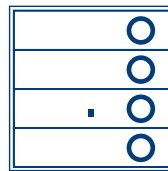

102

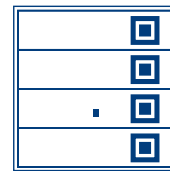

103

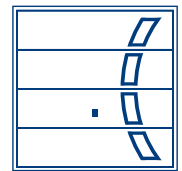

104

| Nominal Door Size<br>Width x Height<br>(mm x mm) | Size<br>Code | 100  |      | 101  |      | 102  |      | 103  |      | 104  |      |
|--|--------------|------|------|------|------|------|------|------|------|------|------|
|  |              | C    | R    | C    | R    | C    | R    | C    | R    | C    | R    |
| 2134 x 1981                                      | 7066         | 1355 | 1404 | 1624 | 1673 | 1624 | 1673 | 1624 | 1673 | 1624 | 1673 |
| 2134 x 2136                                      | 7070         | 1444 | 1493 | 1713 | 1762 | 1713 | 1762 | 1713 | 1762 | 1713 | 1762 |
| 2259 x 1981                                      | 7566         | 1491 | 1540 | 1758 | 1807 | 1758 | 1807 | 1758 | 1807 | 1758 | 1807 |
| 2259 x 2136                                      | 7570         | 1578 | 1627 | 1850 | 1899 | 1850 | 1899 | 1850 | 1899 | 1850 | 1899 |
| 2284 x 1981                                      | 7666         | 1518 | 1567 | 1784 | 1833 | 1784 | 1833 | 1784 | 1833 | 1784 | 1833 |
| 2284 x 2136                                      | 7670         | 1606 | 1655 | 1875 | 1924 | 1875 | 1924 | 1875 | 1924 | 1875 | 1924 |
| 2439 x 1981                                      | 8066         | 1713 | 1762 | 1981 | 2030 | 1981 | 2030 | 1981 | 2030 | 1981 | 2030 |
| 2439 x 2136                                      | 8070         | 1802 | 1851 | 2072 | 2121 | 2072 | 2121 | 2072 | 2121 | 2072 | 2121 |

### Single door

Nominal Door Size  
Width x Height  
(mm x mm)

Size  
Code

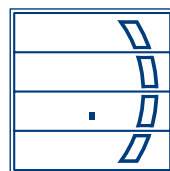

105



106

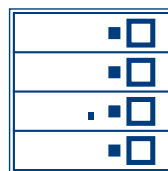

108

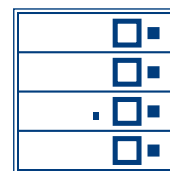

109

| Nominal Door Size<br>Width x Height<br>(mm x mm) | Size<br>Code | 105  |      | 106  |      | 108  |      | 109  |      |
|--|--------------|------|------|------|------|------|------|------|------|
|  |              | C    | R    | C    | R    | C    | R    | C    | R    |
| 2134 x 1981                                      | 7066         | 1624 | 1673 | 1624 | 1673 | 1624 | 1673 | 1624 | 1673 |
| 2134 x 2136                                      | 7070         | 1713 | 1762 | 1713 | 1762 | 1713 | 1762 | 1713 | 1762 |
| 2259 x 1981                                      | 7566         | 1758 | 1807 | 1758 | 1807 | 1758 | 1807 | 1758 | 1807 |
| 2259 x 2136                                      | 7570         | 1850 | 1899 | 1850 | 1899 | 1850 | 1899 | 1850 | 1899 |
| 2284 x 1981                                      | 7666         | 1784 | 1833 | 1784 | 1833 | 1784 | 1833 | 1784 | 1833 |
| 2284 x 2136                                      | 7670         | 1875 | 1924 | 1875 | 1924 | 1875 | 1924 | 1875 | 1924 |
| 2439 x 1981                                      | 8066         | 1981 | 2030 | 1981 | 2030 | 1981 | 2030 | 1981 | 2030 |
| 2439 x 2136                                      | 8070         | 2072 | 2121 | 2072 | 2121 | 2072 | 2121 | 2072 | 2121 |

### Single door

| Nominal Door Size<br>Width x Height<br>(mm x mm) | Size<br>Code | 200  |      | 201  |      | 202  |      | 203  |      | 204  |      |
|--|--------------|------|------|------|------|------|------|------|------|------|------|
|  |              | C    | R    | C    | R    | C    | R    | C    | R    | C    | R    |
| 2134 x 1981                                      | 7066         | 1355 | 1404 | 1624 | 1673 | 1624 | 1673 | 1624 | 1673 | 1624 | 1673 |
| 2134 x 2136                                      | 7070         | 1444 | 1493 | 1713 | 1762 | 1713 | 1762 | 1713 | 1762 | 1713 | 1762 |
| 2259 x 1981                                      | 7566         | 1491 | 1540 | 1758 | 1807 | 1758 | 1807 | 1758 | 1807 | 1758 | 1807 |
| 2259 x 2136                                      | 7570         | 1578 | 1627 | 1850 | 1899 | 1850 | 1899 | 1850 | 1899 | 1850 | 1899 |
| 2284 x 1981                                      | 7666         | 1518 | 1567 | 1784 | 1833 | 1784 | 1833 | 1784 | 1833 | 1784 | 1833 |
| 2284 x 2136                                      | 7670         | 1606 | 1655 | 1875 | 1924 | 1875 | 1924 | 1875 | 1924 | 1875 | 1924 |
| 2439 x 1981                                      | 8066         | 1713 | 1762 | 1981 | 2030 | 1981 | 2030 | 1981 | 2030 | 1981 | 2030 |
| 2439 x 2136                                      | 8070         | 1802 | 1851 | 2072 | 2121 | 2072 | 2121 | 2072 | 2121 | 2072 | 2121 |

### Single door

| Nominal Door Size<br>Width x Height<br>(mm x mm) | Size<br>Code | 205  |      | 210  |      | 211  |      | 212  |      |
|--|--------------|------|------|------|------|------|------|------|------|
|  |              | C    | R    | C    | R    | C    | R    | C    | R    |
| 2134 x 1981                                      | 7066         | 1624 | 1673 | 1624 | 1673 | 1624 | 1673 | 1624 | 1673 |
| 2134 x 2136                                      | 7070         | 1713 | 1762 | 1713 | 1762 | 1713 | 1762 | 1713 | 1762 |
| 2259 x 1981                                      | 7566         | 1758 | 1807 | 1758 | 1807 | 1758 | 1807 | 1758 | 1807 |
| 2259 x 2136                                      | 7570         | 1850 | 1899 | 1850 | 1899 | 1850 | 1899 | 1850 | 1899 |
| 2284 x 1981                                      | 7666         | 1784 | 1833 | 1784 | 1833 | 1784 | 1833 | 1784 | 1833 |
| 2284 x 2136                                      | 7670         | 1875 | 1924 | 1875 | 1924 | 1875 | 1924 | 1875 | 1924 |
| 2439 x 1981                                      | 8066         | 1981 | 2030 | 1981 | 2030 | 1981 | 2030 | 1981 | 2030 |
| 2439 x 2136                                      | 8070         | 2072 | 2121 | 2072 | 2121 | 2072 | 2121 | 2072 | 2121 |

### Options for single doors

add

|  |     |
|--|-----|
| Factory pre-fitted steel frame                         | 178 |
| Additional Lock Kit, C-type/ R-type (fitted onto door) | 83  |
| Retractable plus gear                                  | 85  |
| Poly-wrapping  | 47  |

Please specify on order if you would like the design elements on the right or the left hand side of the door panel (viewed from outside).

Colour options on Design Range doors are free of charge. Available options are: White (RAL 9016), Terra Brown (RAL 8028), Moss Green (RAL 6005), Ruby Red (RAL 3003), Signal Blue (RAL 5005), Jet Black (RAL 9005), Steel Blue (RAL 5011), Light Ivory (RAL 1015), Pigeon Blue (RAL 5014), Fir Green (RAL 6009), Anthracite Grey (RAL 7016), Stone Grey (RAL 7030), Light Grey (RAL 7035), Slate Grey (RAL 7015), Agate Grey (RAL 7038), Window Grey (RAL 7040), Chartwell Green (BS 4800), Burgundy Brown and Golden Brown (solid).

# GRP Premier Panel Doors

## Surface

High gloss or woodgrain finish depending on door style.

GRP Premier doors are constructed as an infill panel and are fixed into a rigid box section chassis.

The infill has a flow coat to the inside face for a smoother finish and reduced translucency.

Please note: panel doors are produced with appearance in mind. This may result in some small gaps which could allow water ingress especially in exposed locations.

## Standard colours

Arden and Stamford are available in Gloss White and Gloss Magnolia finish only. All other doors are available in the following range of woodgrain colours: White, Magnolia, Bleached Oak, Red Mahogany, Dark Mahogany, Light Oak, Dark Oak, Irish Oak, Honey Beech, Teak, Golden Brown, Ebony and Anthracite Grey.

Due to the production processes door colours may vary. Should you require matching doors please specify on your order.

Please note when trying to colour match garage doors with other UPVC products always check a colour sample first. The gel coats used in the process will not necessarily be a match and we will not guarantee a match with any other product.

## Premium colours

Our GRP premium colour range includes Blue and Green. There is an additional surcharge for these colours, see page 24 for details.

## Chassis colour

Traffic White (RAL 9016) for White Woodgrain and Gloss White doors, Black (RAL 9005) for Ebony coloured doors, Anthracite Grey (RAL 7016) for Anthracite Grey doors, Light Ivory (RAL 1015) for Magnolia Gloss and Magnolia doors, Fir Green (RAL 6009) for Green doors and Steel Blue (RAL 5011) for Blue doors.

Burgundy Brown will be used as the chassis colour for Red Mahogany, Dark Oak and Dark Mahogany.

All other doors will be supplied with a Terra Brown (RAL 8028) chassis.

## Handle

Black handle and base plate as standard, optional handles available. Doors can be supplied undrilled and without handle and locking mechanism for use with electric operator. This must be requested at the time of order.

Certain panel configurations may only be available without handle or locking, therefore only suitable for electric operation (consult Garador sales office for exact details).

## Terminology

Nominal Door Size: This is the actual door panel size plus the fitting tolerances. The nominal door size should be used for internal dimensions of a timber frame.

Size Code: This has traditionally been used to order doors. This may not be the actual door size.

## Packaging

Supplied with front surface protection as standard.

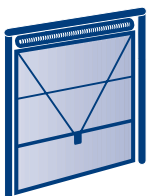

### Canopy gearing (shown as C)

Canopy gear is available for all single doors providing a reliable and affordable gearing solution, with no tracks running back into the garage.

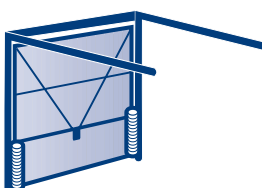

### Retractable gearing (shown as R)

Retractable gear is available for all single and double doors providing a reliable and affordable gearing solution, with tracks running back into the garage.

Single door

Nominal Door Size  
Width x Height  
(mm x mm)

Size  
Code

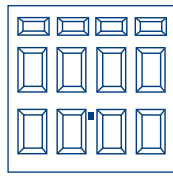

Arden

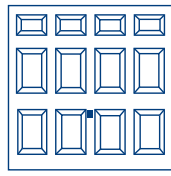

Kenmore

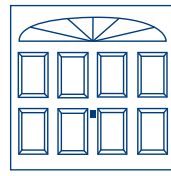

Stamford

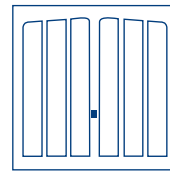

Penshurst

| Nominal Door Size<br>Width x Height<br>(mm x mm) | Size<br>Code | Arden |                   | Kenmore |                   | Stamford |      | Penshurst |      |
|--|--------------|-------|-------------------|---------|-------------------|----------|------|-----------|------|
|  |              | C     | R                 | C       | R                 | C        | R    | C         | R    |
| 2134 x 1981                                      | 7066         | 2712  | 2761              | 2767    | 2816              | 2847     | 2896 | 2935      | 2984 |
| 2134 x 2136                                      | 7070         | 2712  | 2761              | 2767    | 2816              | 2847     | 2896 | 2935      | 2984 |
| 2259 x 1981                                      | 7566         | 2837  | 2886              | 2910    | 2959              | 2961     | 3010 | 3163      | 3212 |
| 2259 x 2136                                      | 7570         | 2837  | 2886              | 2910    | 2959              | 2961     | 3010 | 3163      | 3212 |
| 2284 x 1981                                      | 7666         | 2859  | 2908              | 2935    | 2984              | 2994     | 3043 | 3193      | 3242 |
| 2284 x 2136                                      | 7670         | 2859  | 2908              | 2935    | 2984              | 2994     | 3043 | 3193      | 3242 |
| 2439 x 1981                                      | 8066         | 3123  | 3172              | 3156    | 3205              | 3241     | 3290 | 3398      | 3447 |
| 2439 x 2136                                      | 8070         | 3123  | 3172              | 3156    | 3205              | 3241     | 3290 | 3398      | 3447 |
| 2744 x 1981                                      | 9066         | -     | 3480 <sup>1</sup> | -       | 3563 <sup>1</sup> | -        | -    | -         | -    |
| 2744 x 2136                                      | 9070         | -     | 3480 <sup>1</sup> | -       | 3563 <sup>1</sup> | -        | -    | -         | -    |
| 3049 x 1981                                      | 1066         | -     | 3820 <sup>1</sup> | -       | 3942 <sup>1</sup> | -        | -    | -         | -    |
| 3049 x 2136                                      | 1070         | -     | 3820 <sup>1</sup> | -       | 3942 <sup>1</sup> | -        | -    | -         | -    |

<sup>1</sup> Doors only available with electric operation (Handle and Locking not available).

Single door

Nominal Door Size  
Width x Height  
(mm x mm)

Size  
Code

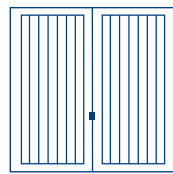

Swinton

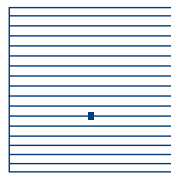

Glastonbury

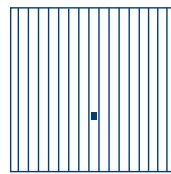

Somerset

| Nominal Door Size<br>Width x Height<br>(mm x mm) | Size<br>Code | Swinton |      | Glastonbury |      | Somerset |      |
|--|--------------|---------|------|-------------|------|----------|------|
|  |              | C       | R    | C           | R    | C        | R    |
| 2134 x 1981                                      | 7066         | 2935    | 2984 | 2935        | 2984 | 2935     | 2984 |
| 2134 x 2136                                      | 7070         | 2935    | 2984 | 2935        | 2984 | 2935     | 2984 |
| 2259 x 1981                                      | 7566         | 3163    | 3212 | 3163        | 3212 | 3163     | 3212 |
| 2259 x 2136                                      | 7570         | 3163    | 3212 | 3163        | 3212 | 3163     | 3212 |
| 2284 x 1981                                      | 7666         | 3193    | 3242 | 3193        | 3242 | 3193     | 3242 |
| 2284 x 2136                                      | 7670         | 3193    | 3242 | 3193        | 3242 | 3193     | 3242 |
| 2439 x 1981                                      | 8066         | 3398    | 3447 | -           | -    | 3398     | 3447 |
| 2439 x 2136                                      | 8070         | 3398    | 3447 | -           | -    | 3398     | 3447 |
| 2744 x 1981                                      | 9066         | -       | -    | -           | -    | -        | 3807 |
| 2744 x 2136                                      | 9070         | -       | -    | -           | -    | -        | 3807 |
| 3049 x 1981                                      | 1066         | -       | -    | -           | -    | -        | 4180 |
| 3049 x 2136                                      | 1070         | -       | -    | -           | -    | -        | 4180 |

Please note that doors with windows may have cross bracing or locking rods passing behind the windows depending upon size and gear type.

For further options please see page 24.

### Single door

Nominal Door Size  
Width x Height  
(mm x mm)

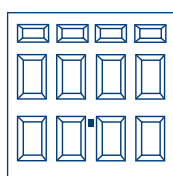

Arden

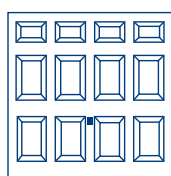

Kenmore

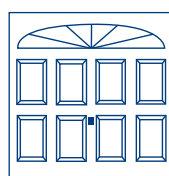

Stamford

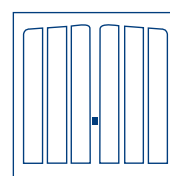

Penshurst

| Nominal Door Size<br>Width x Height<br>(mm x mm) | Arden |                   | Kenmore |                   | Stamford |      | Penshurst |      |
|--|-------|-------------------|---------|-------------------|----------|------|-----------|------|
|  | C     | R                 | C       | R                 | C        | R    | C         | R    |
| 2032-2133 x 1931-1980                            | -     | -                 | -       | -                 | -        | -    | 3241      | 3290 |
| 2032-2133 x 1981-2136                            | -     | -                 | -       | -                 | -        | -    | 3241      | 3290 |
| 2032-2133 x 2137-2286                            | -     | -                 | -       | -                 | -        | -    | -         | 3744 |
| 2134-2439 x 1931-1980                            | -     | -                 | -       | -                 | -        | -    | 3720      | 3769 |
| 2134-2439 x 1981-2136                            | 3420  | 3469              | 3459    | 3508              | 3557     | 3606 | 3720      | 3769 |
| 2134-2439 x 2137-2286                            | -     | 3944              | -       | 3992              | -        | -    | -         | 4303 |
| 2440-2590 x 1931-1980                            | -     | -                 | -       | -                 | -        | -    | -         | -    |
| 2440-2590 x 1981-2136                            | -     | -                 | -       | -                 | -        | -    | -         | -    |
| 2440-2590 x 2137-2286                            | -     | -                 | -       | -                 | -        | -    | -         | -    |
| 2591-2744 x 1931-1980                            | -     | -                 | -       | -                 | -        | -    | -         | -    |
| 2591-2744 x 1981-2136                            | -     | -                 | -       | 3983 <sup>1</sup> | -        | -    | -         | -    |
| 2591-2744 x 2137-2286                            | -     | -                 | -       | -                 | -        | -    | -         | -    |
| 2745-2896 x 1931-1980                            | -     | -                 | -       | -                 | -        | -    | -         | -    |
| 2745-2896 x 1981-2136                            | -     | 4238 <sup>1</sup> | -       | 4353 <sup>1</sup> | -        | -    | -         | -    |
| 2745-2896 x 2137-2286                            | -     | -                 | -       | -                 | -        | -    | -         | -    |
| 2897-3049 x 1931-1980                            | -     | -                 | -       | -                 | -        | -    | -         | -    |
| 2897-3049 x 1981-2136                            | -     | 4238 <sup>1</sup> | -       | 4353 <sup>1</sup> | -        | -    | -         | -    |
| 2897-3049 x 2137-2286                            | -     | -                 | -       | -                 | -        | -    | -         | -    |

<sup>1</sup> Doors only available with electric operation (Handle and Locking not available).

### Single door

Nominal Door Size  
Width x Height  
(mm x mm)

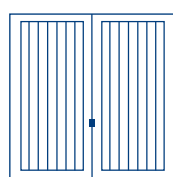

Swinton

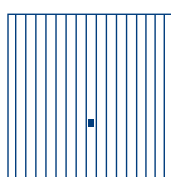

Somerset

| Nominal Door Size<br>Width x Height<br>(mm x mm) | Swinton |      | Somerset |      |
|--|---------|------|----------|------|
|  | C       | R    | C        | R    |
| 2259-2439 x 1981-2136                            | 3720    | 3769 | 3720     | 3769 |
| 2259-2439 x 2150-2286                            | -       | 4027 | -        | 3775 |
| 2440-2590 x 1931-1980                            | -       | -    | -        | 3831 |
| 2440-2590 x 1981-2136                            | -       | -    | -        | 3831 |
| 2440-2590 x 2137-2286                            | -       | -    | -        | 3831 |
| 2591-2744 x 1931-1980                            | -       | -    | -        | 4058 |
| 2591-2744 x 1981-2136                            | -       | -    | -        | 4058 |
| 2591-2744 x 2137-2286                            | -       | -    | -        | 4058 |
| 2745-2896 x 1931-1980                            | -       | -    | -        | 4378 |
| 2745-2896 x 1981-2136                            | -       | -    | -        | 4378 |
| 2745-2896 x 2137-2286                            | -       | -    | -        | 4378 |
| 2897-3049 x 1931-1980                            | -       | -    | -        | 4636 |
| 2897-3049 x 1981-2136                            | -       | -    | -        | 4636 |
| 2897-3049 x 2137-2286                            | -       | -    | -        | 4636 |

Orders for purpose made sizes will only be accepted as nominal door size for unframed version and overall frame size when ordering a framed version. Orders for purpose made framed doors will not be accepted as nominal door size. Please note that doors with windows may have cross bracing or locking rods passing behind the windows depending upon size and gear type. For further options please see page 24.

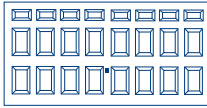
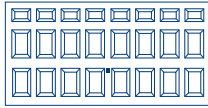
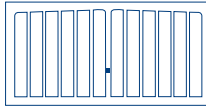
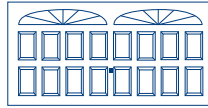
| Double door                                      |              |  |  |  |  |
|--|--------------|---|---|--|---|
| Nominal Door Size<br>Width x Height<br>(mm x mm) | Size<br>Code | Arden<br>R  | Kenmore<br>R  | Penshurst<br>R   | Stamford<br>R   |
| 3354 x 1981                                      | 1166         | 3820  | 3973  | -  | -   |
| 3354 x 2136                                      | 1170         | 3820  | 3973  | -  | -   |
| 3354 x 2286                                      | 1176         | 3820  | -   | -  | -   |
| 3659 x 1981                                      | 1266         | 4135 <sup>1</sup>   | 4316 <sup>1</sup>   | -  | -   |
| 3659 x 2136                                      | 1270         | 4135 <sup>1</sup>   | 4316 <sup>1</sup>   | -  | -   |
| 3659 x 2286                                      | 1276         | 4135  | -   | -  | -   |
| 3964 x 1981                                      | 1366         | 4442 <sup>1</sup>   | 4661 <sup>1</sup>   | -  | -   |
| 3964 x 2136                                      | 1370         | 4442 <sup>1</sup>   | 4661 <sup>1</sup>   | -  | -   |
| 3964 x 2286                                      | 1376         | 4442  | -   | -  | -   |
| 4269 x 1981                                      | 1466         | 4750  | 5018  | 5228   | 5247 <sup>1</sup>   |
| 4269 x 2136                                      | 1470         | 4750  | 5018  | 5228   | 5247 <sup>1</sup>   |
| 4269 x 2286                                      | 1476         | 4750  | -   | -  | -   |

<sup>1</sup> Doors only available with electric operation (Handle and Locking not available).

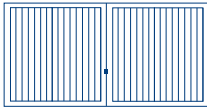
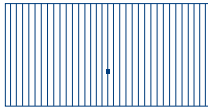
| Double door                                      |              |  |  |
|--|--------------|--|--|
| Nominal Door Size<br>Width x Height<br>(mm x mm) | Size<br>Code | Swinton<br>R   | Somerset<br>R  |
| 3354 x 1981                                      | 1166         | -  | 3973   |
| 3354 x 2136                                      | 1170         | -  | 3973   |
| 3354 x 2286                                      | 1176         | -  | -  |
| 3659 x 1981                                      | 1266         | -  | 4316   |
| 3659 x 2136                                      | 1270         | -  | 4316   |
| 3659 x 2286                                      | 1276         | -  | -  |
| 3964 x 1981                                      | 1366         | -  | 4661   |
| 3964 x 2136                                      | 1370         | -  | 4661   |
| 3964 x 2286                                      | 1376         | -  | -  |
| 4269 x 1981                                      | 1466         | -  | 5094   |
| 4269 x 2136                                      | 1470         | 5247   | 5094   |
| 4269 x 2286                                      | 1476         | -  | -  |

<sup>1</sup> Doors only available with electric operation (Handle and Locking not available).

Please note that doors with windows may have cross bracing or locking rods passing behind the windows depending upon size and gear type.

For further options please see page 24.

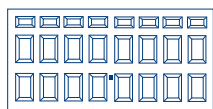
**Double door**Nominal Door Size  
Width x Height  
(mm x mm)

Arden

R

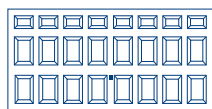

Kenmore

R

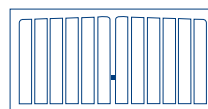

Penshurst

R

|           |   |           |                   |                   |      |
|-----------|---|-----------|-------------------|-------------------|------|
| 3050-3355 | x | 1981-2136 | 4081              | 4246              | -    |
| 3050-3355 | x | 2137-2286 | 4230              | -                 | -    |
| 3356-3660 | x | 1981-2136 | 4385 <sup>1</sup> | 4591 <sup>1</sup> | -    |
| 3356-3660 | x | 2137-2286 | 4535              | -                 | -    |
| 3661-3965 | x | 1981-2136 | 4693 <sup>1</sup> | 4935 <sup>1</sup> | -    |
| 3661-3965 | x | 2137-2286 | 4844              | -                 | -    |
| 3966-4117 | x | 1981-2136 | 4999 <sup>1</sup> | 5266 <sup>1</sup> | -    |
| 3966-4117 | x | 2137-2286 | 4999              | -                 | -    |
| 4118-4269 | x | 1981-2136 | 4999              | 5266              | 5484 |
| 4118-4269 | x | 2137-2286 | 5290              | -                 | -    |

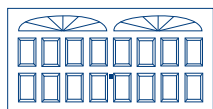
<sup>1</sup> Doors only available with electric operation (Handle and Locking not available).**Double door**Nominal Door Size  
Width x Height  
(mm x mm)

Stamford

R

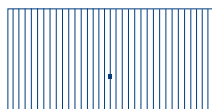

Somerset

R

|           |   |           |                   |      |
|-----------|---|-----------|-------------------|------|
| 3050-3355 | x | 1981-2136 | -                 | 4246 |
| 3050-3355 | x | 2137-2286 | -                 | 4246 |
| 3356-3660 | x | 1981-2136 | -                 | 4591 |
| 3356-3660 | x | 2137-2286 | -                 | 4591 |
| 3661-3965 | x | 1981-2136 | -                 | 4935 |
| 3661-3965 | x | 2137-2286 | -                 | 4935 |
| 3966-4117 | x | 1981-2136 | -                 | 5266 |
| 3966-4117 | x | 2137-2286 | -                 | 5266 |
| 4118-4269 | x | 1981-2136 | 5519 <sup>1</sup> | 5484 |
| 4118-4269 | x | 2137-2286 | -                 | 5484 |







<sup>1</sup> Doors only available with electric operation (Handle and Locking not available).

Orders for purpose made sizes will only be accepted as nominal door size for unframed version and overall frame size when ordering a framed version. Orders for purpose made framed doors will not be accepted as nominal door size.

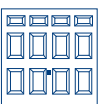
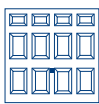





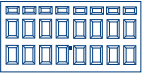

**Options**

| Options   | Single doors<br>add | Double doors<br>add |
|---|---------------------|---------------------|
| Factory pre-framed standard single doors  | 178                 | -                   |
| Steel frame for standard double doors   | -                   | 267                 |
| Factory pre-framed purpose-made single doors  | 201                 | -                   |
| Steel frame for purpose-made double doors   | -                   | 297                 |
| Additional Lock Kit, C-type/ R-type (fitted onto door)  | 83                  | -                   |
| Retractable plus gear available on 1931, 1981 and 2136 mm high doors up to 2744 mm wide               | 85                  | -                   |
| Diecast metal handles with matching base plates: brass effect, brushed steel, chrome effect and white | 124                 | 124                 |
| Surcharge for Premium colours Green and Blue  | 407                 | 809                 |
| Surcharge for steel frame in colour not matching garage door  | 176                 | 275                 |
| Surcharge for colour steel frame on Matt or Gloss White Garage door                                   | 176                 | 275                 |



| GRP<br>Window options<br>for standard<br>and purpose-made<br>single doors   |  |  |  | Additional Cost<br>(Width mm) |           |
|---|---|---|---|-------------------------------|-----------|
|   |   |   |   | up to 2743                    | 2744-3049 |
|  Clear Perspex   | X   | X   | X   | 221                           | 327       |
|  Stippled Perspex  | X   | X   | X   | 222                           | 327       |
|  Stippled Perspex with diamond leading                         | -   | X   | X   | 363                           | 533       |
|  Stippled Perspex with square leading                          | -   | X   | X   | 363                           | 533       |
|  Black Non-Translucent   | X   | X   | X   | 222                           | 327       |
|  Black Non-Translucent Perspex with border and diamond leading | -   | X   | X   | 363                           | 533       |

Please state window code on order.

| GRP<br>Window options<br>for standard<br>and purpose-made<br>double doors   |  |  |  | Additional Cost<br>(Width mm) |             |
|---|--|--|--|-------------------------------|-------------|
|   |  |  |  | 3354 - 3963                   | 3964 - 4269 |
|  Clear Perspex   | X  | X  | X  | 383                           | 436         |
|  Stippled Perspex  | X  | X  | X  | 383                           | 436         |
|  Stippled Perspex with diamond leading                         | -  | X  | X  | 624                           | 748         |
|  Stippled Perspex with square leading                          | -  | X  | X  | 624                           | 748         |
|  Black Non-Translucent   | X  | X  | X  | 383                           | 436         |
|  Black Non-Translucent Perspex with border and diamond leading | -  | X  | X  | 624                           | 748         |

Please state window code on order.

Please note that doors with windows may have cross bracing or locking rods passing behind the windows depending upon size and gear type.

# Timber Panel Doors

## Surface

Timber doors are supplied untreated and require immediate on-site finishing unless fully finished option specified. Timber is a natural material and therefore Garador cannot guarantee to be able to produce matching timber garage doors. Chassis colours will be Brown (RAL 8028) on all timber doors

Please note: panel doors are produced with appearance in mind. This may result in some small gaps which could allow water ingress especially in exposed locations.

## Handle

Black handle and base plate supplied as standard, optional handles available. Doors can alternatively be supplied undrilled and without handle and locking mechanism for use with electric operator.

## Packaging

Supplied wrapped with additional foam protection on surface of panel as standard.

## Terminology

**Nominal Door Size:** This is the actual door panel size plus the fitting tolerances. The nominal door size should be used for internal dimensions of a timber frame.

**Size Code:** This has traditionally been used to order doors. This may not be the actual door size.

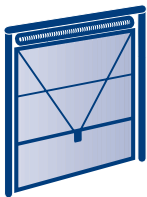

### Canopy gearing (shown as C)

Canopy gear is available for all single doors providing a reliable and affordable gearing solution, with no tracks running back into the garage.

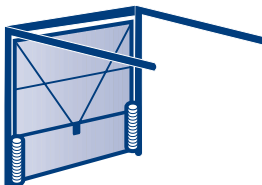

### Retractable gearing (shown as R)

Retractable gear is available for all single and double doors providing a reliable and affordable gearing solution, with tracks running back into the garage.

Single door

Nominal Door Size  
Width x Height  
(mm x mm)

Size  
Code

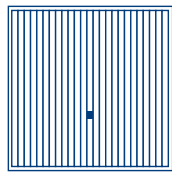

Vertical Timber

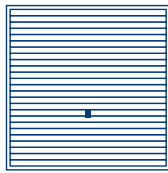

Horizontal Timber

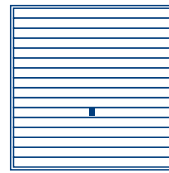

Countryman

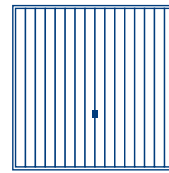

Hampton

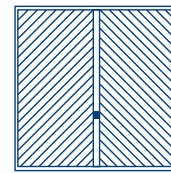

Chevron Timber

| Nominal Door Size<br>Width x Height<br>(mm x mm) | Size<br>Code | Vertical Timber |      | Horizontal Timber |      | Countryman |      | Hampton |      | Chevron Timber |      |
|--|--------------|-----------------|------|-------------------|------|------------|------|---------|------|----------------|------|
|  |              | C               | R    | C                 | R    | C          | R    | C       | R    | C              | R    |
| 2134 x 1981                                      | 7066         | 2814            | 2863 | 2961              | 3010 | 3514       | 3563 | 3514    | 3563 | 4184           | 4233 |
| 2134 x 2136                                      | 7070         | 2842            | 2891 | 2987              | 3036 | 3543       | 3592 | 3543    | 3592 | 4251           | 4300 |
| 2134 x 2286                                      | 7076         | -               | 3216 | -                 | 3378 | -          | 3984 | -       | 3984 | -              | 4487 |
| 2259 x 1981                                      | 7566         | 2961            | 3010 | 3115              | 3164 | 3696       | 3745 | 3696    | 3745 | 4464           | 4513 |
| 2259 x 2136                                      | 7570         | 2988            | 3037 | 3145              | 3194 | 3728       | 3777 | 3728    | 3777 | 4485           | 4534 |
| 2284 x 1981                                      | 7666         | 2961            | 3010 | 3413              | 3462 | 3696       | 3745 | 3696    | 3745 | 4464           | 4513 |
| 2284 x 2136                                      | 7670         | 2988            | 3037 | 3145              | 3194 | 3728       | 3777 | 3728    | 3777 | 4485           | 4534 |
| 2284 x 2286                                      | 7676         | -               | 3335 | -                 | 3508 | -          | 3997 | -       | 3997 | -              | 4706 |
| 2439 x 1981                                      | 8066         | 3134            | 3183 | 3299              | 3348 | 3907       | 3956 | 3907    | 3956 | 4611           | 4660 |
| 2439 x 2136                                      | 8070         | 3157            | 3206 | 3323              | 3372 | 3938       | 3987 | 3938    | 3987 | 4637           | 4686 |
| 2439 x 2286                                      | 8076         | -               | 3539 | -                 | 3712 | -          | 4235 | -       | 4235 | -              | 4832 |
| 2744 x 1981                                      | 9066         | -               | 3693 | -                 | 3881 | -          | 4409 | -       | 4409 | -              | 5142 |
| 2744 x 2136                                      | 9070         | -               | 3718 | -                 | 3903 | -          | 4457 | -       | 4457 | -              | 5215 |
| 2744 x 2286                                      | 9076         | -               | 4056 | -                 | 4266 | -          | 4771 | -       | 4771 | -              | 5390 |
| 3049 x 1981                                      | 1066         | -               | 4275 | -                 | 4485 | -          | 4980 | -       | 4980 | -              | 5772 |
| 3049 x 2136                                      | 1070         | -               | 4314 | -                 | 4534 | -          | 5021 | -       | 5021 | -              | 5818 |

Single door

Nominal Door Size  
Width x Height  
(mm x mm)

Size  
Code

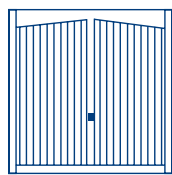

Barrington

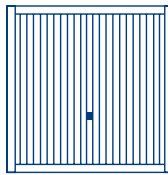

Kingsbury

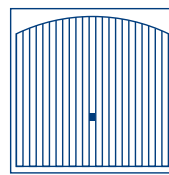

Adlington



Ashton<sup>1</sup>

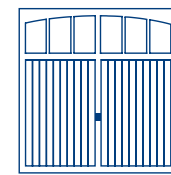

Rochdale<sup>1</sup>

| Nominal Door Size<br>Width x Height<br>(mm x mm) | Size<br>Code | Barrington |      | Kingsbury |      | Adlington |      | Ashton <sup>1</sup> |      | Rochdale <sup>1</sup> |      |
|--|--------------|------------|------|-----------|------|-----------|------|---------------------|------|-----------------------|------|
|  |              | C          | R    | C         | R    | C         | R    | C                   | R    | C                     | R    |
| 2134 x 1981                                      | 7066         | 3573       | 3622 | 3543      | 3592 | 3220      | 3269 | 4184                | 4233 | 4228                  | 4277 |
| 2134 x 2136                                      | 7070         | 3596       | 3645 | 3571      | 3620 | 3220      | 3269 | 4251                | 4300 | 4257                  | 4306 |
| 2134 x 2286                                      | 7076         | -          | 3983 | -         | 3948 | -         | 3559 | -                   | 4487 | -                     | 4541 |
| 2259 x 1981                                      | 7566         | 3715       | 3764 | 3684      | 3733 | 3360      | 3409 | 4464                | 4513 | 4383                  | 4432 |
| 2259 x 2136                                      | 7570         | 3738       | 3787 | 3712      | 3761 | 3381      | 3430 | 4485                | 4534 | 4404                  | 4453 |
| 2284 x 1981                                      | 7666         | 3715       | 3764 | 3684      | 3733 | 3360      | 3409 | 4464                | 4513 | 4383                  | 4432 |
| 2284 x 2136                                      | 7670         | 3738       | 3787 | 3712      | 3761 | 3381      | 3430 | 4485                | 4534 | 4404                  | 4453 |
| 2284 x 2286                                      | 7676         | -          | 4115 | -         | 4085 | -         | 3718 | -                   | 4706 | -                     | 4627 |
| 2439 x 1981                                      | 8066         | 3845       | 3894 | 3812      | 3861 | 3696      | 3745 | 4611                | 4660 | 4522                  | 4571 |
| 2439 x 2136                                      | 8070         | 3870       | 3919 | 3840      | 3889 | 3696      | 3745 | 4637                | 4686 | 4559                  | 4608 |
| 2439 x 2286                                      | 8076         | -          | 4235 | -         | 4199 | -         | 3787 | -                   | 4832 | -                     | 4742 |
| 2744 x 1981                                      | 9066         | -          | 4386 | -         | 4239 | -         | 3939 | -                   | 5142 | -                     | 5174 |
| 2744 x 2136                                      | 9070         | -          | 4425 | -         | 4275 | -         | 3939 | -                   | 5215 | -                     | 5257 |
| 2744 x 2286                                      | 9076         | -          | 4769 | -         | 4627 | -         | 4251 | -                   | 5390 | -                     | 5423 |
| 3049 x 1981                                      | 1066         | -          | 4960 | -         | 4814 | -         | 4258 | -                   | 5772 | -                     | 5815 |
| 3049 x 2136                                      | 1070         | -          | 5001 | -         | 4853 | -         | 4258 | -                   | 5818 | -                     | 5856 |

<sup>1</sup> Ashton and Rochdale doors may have cross bracing and / or locking rods behind the windows depending upon the size and gear type.

For further options please see page 35.

Single door

Nominal Door Size  
Width x Height  
(mm x mm)

Size  
Code

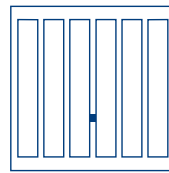
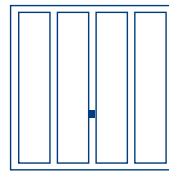
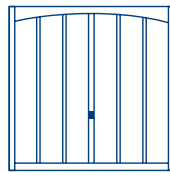
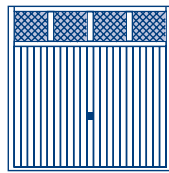

Sandhurst<sup>1</sup>

Shaftesbury

Grantham

Seymour

| Nominal Door Size<br>Width x Height<br>(mm x mm) | Size<br>Code | Sandhurst <sup>1</sup> |      | Shaftesbury |      | Grantham |      | Seymour |      |
|--|--------------|------------------------|------|-------------|------|----------|------|---------|------|
|  |              | C                      | R    | C           | R    | C        | R    | C       | R    |
| 2134 x 1981                                      | 7066         | 4099                   | 4148 | 3176        | 3225 | 2139     | 2188 | 3033    | 3082 |
| 2134 x 2136                                      | 7070         | 4124                   | 4173 | 3194        | 3243 | 2139     | 2188 | 3062    | 3111 |
| 2134 x 2286                                      | 7076         | -                      | 4404 | -           | 3436 | -        | 2358 | -       | 3293 |
| 2259 x 1981                                      | 7566         | 4250                   | 4299 | 3237        | 3286 | 2277     | 2326 | 3099    | 3148 |
| 2259 x 2136                                      | 7570         | 4275                   | 4324 | 3259        | 3308 | 2277     | 2326 | 3123    | 3172 |
| 2284 x 1981                                      | 7666         | 4250                   | 4299 | 3237        | 3286 | 2277     | 2326 | 3099    | 3148 |
| 2284 x 2136                                      | 7670         | 4275                   | 4324 | 3259        | 3308 | 2277     | 2326 | 3123    | 3172 |
| 2284 x 2286                                      | 7676         | -                      | 4495 | -           | 3480 | -        | 2520 | -       | 3342 |
| 2439 x 1981                                      | 8066         | 4391                   | 4440 | 3291        | 3340 | 2364     | 2413 | 3151    | 3200 |
| 2439 x 2136                                      | 8070         | 4426                   | 4475 | 3319        | 3368 | 2364     | 2413 | 3176    | 3225 |
| 2439 x 2286                                      | 8076         | -                      | 4610 | -           | 3511 | -        | 2620 | -       | 3371 |
| 2744 x 1981                                      | 9066         | -                      | 4975 | -           | 3983 | -        | 2684 | -       | 3813 |
| 2744 x 2136                                      | 9070         | -                      | 5057 | -           | 4016 | -        | 2684 | -       | 3840 |
| 2744 x 2286                                      | 9076         | -                      | 5227 | -           | 4202 | -        | 2869 | -       | 4000 |
| 3049 x 1981                                      | 1066         | -                      | 5614 | -           | 4478 | -        | 2916 | -       | 4297 |
| 3049 x 2136                                      | 1070         | -                      | 5655 | -           | 4520 | -        | 2916 | -       | 4300 |

<sup>1</sup> Sandhurst doors may have cross bracing and/or locking rods behind the windows depending upon the size and gear type.

Single door

Nominal Door Size  
Width x Height  
(mm x mm)

Size  
Code

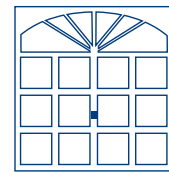
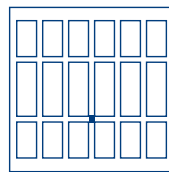
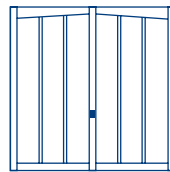
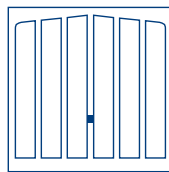

Tudor

Bosworth

Wolsley

Hinton<sup>2</sup>

| Nominal Door Size<br>Width x Height<br>(mm x mm) | Size<br>Code | Tudor |      | Bosworth |      | Wolsley |      | Hinton <sup>2</sup> |      |
|--|--------------|-------|------|----------|------|---------|------|---------------------|------|
|  |              | C     | R    | C        | R    | C       | R    | C                   | R    |
| 2134 x 1981                                      | 7066         | 3176  | 3225 | 3217     | 3266 | 3173    | 3222 | 4400                | 4449 |
| 2134 x 2136                                      | 7070         | 3194  | 3243 | 3238     | 3287 | 3192    | 3241 | 4427                | 4476 |
| 2134 x 2286                                      | 7076         | -     | 3436 | -        | 3477 | -       | 3432 | -                   | 4666 |
| 2259 x 1981                                      | 7566         | 3237  | 3286 | 3281     | 3330 | 3234    | 3283 | 4675                | 4724 |
| 2259 x 2136                                      | 7570         | 3259  | 3308 | 3305     | 3354 | 3255    | 3304 | 4701                | 4750 |
| 2284 x 1981                                      | 7666         | 3237  | 3286 | 3281     | 3330 | 3234    | 3283 | 4675                | 4724 |
| 2284 x 2136                                      | 7670         | 3259  | 3308 | 3305     | 3354 | 3255    | 3304 | 4701                | 4750 |
| 2284 x 2286                                      | 7676         | -     | 3480 | -        | 3527 | -       | 3478 | -                   | 4916 |
| 2439 x 1981                                      | 8066         | 3291  | 3340 | 3333     | 3382 | 3288    | 3337 | 4813                | 4862 |
| 2439 x 2136                                      | 8070         | 3319  | 3368 | 3354     | 3403 | 3310    | 3359 | 4843                | 4892 |
| 2439 x 2286                                      | 8076         | -     | 3511 | -        | 3555 | -       | 3509 | -                   | 5033 |
| 2744 x 1981                                      | 9066         | -     | 3983 | -        | 4025 | -       | 3884 | -                   | 5435 |
| 2744 x 2136                                      | 9070         | -     | 4016 | -        | 4052 | -       | 3914 | -                   | 5465 |
| 2744 x 2286                                      | 9076         | -     | 4202 | -        | 4241 | -       | 4073 | -                   | 5646 |
| 3049 x 1981                                      | 1066         | -     | 4478 | -        | 4520 | -       | 4339 | -                   | 6141 |
| 3049 x 2136                                      | 1070         | -     | 4520 | -        | 4559 | -       | 4343 | -                   | 6177 |

<sup>2</sup> Hinton doors may have cross bracing and/or locking rods behind the windows depending upon the size and gear type.

For further options please see page 35.

### Single door

Nominal Door Size  
Width x Height  
(mm x mm)

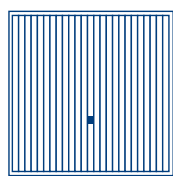

Vertical Timber

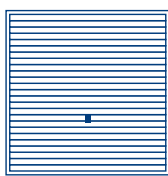

Horizontal Timber

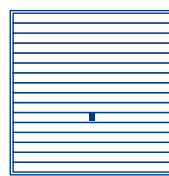

Countryman

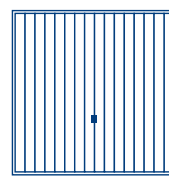

Hampton

|           |             | Vertical Timber   |      | Horizontal Timber |      | Countryman        |      | Hampton           |      |
|-----------|-------------|-------------------|------|-------------------|------|-------------------|------|-------------------|------|
|           |             | C                 | R    | C                 | R    | C                 | R    | C                 | R    |
| 1930-1984 | x 1931-1981 | 3063              | 3112 | 3219              | 3268 | 4286              | 4335 | 4286              | 4335 |
| 1930-1984 | x 1982-2136 | 3082              | 3131 | 3243              | 3292 | 4409              | 4458 | 4409              | 4458 |
| 1930-1984 | x 2137-2286 | -                 | 3454 | -                 | 3628 | -                 | 4776 | -                 | 4776 |
| 1930-1984 | x 2287-2439 | -                 | 3539 | -                 | 3712 | -                 | 5122 | -                 | 5122 |
| 1985-2284 | x 1931-1981 | 3202              | 3251 | 3369              | 3418 | 4516              | 4565 | 4516              | 4565 |
| 1985-2284 | x 1982-2136 | 3228              | 3277 | 3395              | 3444 | 4658              | 4707 | 4658              | 4707 |
| 1985-2284 | x 2137-2286 | -                 | 3573 | -                 | 3749 | -                 | 5016 | -                 | 5016 |
| 1985-2284 | x 2287-2439 | -                 | 3657 | -                 | 3837 | -                 | 5428 | -                 | 5428 |
| 2285-2439 | x 1931-1981 | 3371 <sup>1</sup> | 3420 | 3549 <sup>1</sup> | 3598 | 4581 <sup>1</sup> | 4630 | 4581 <sup>1</sup> | 4630 |
| 2285-2439 | x 1982-2136 | 3395 <sup>1</sup> | 3444 | 3573 <sup>1</sup> | 3622 | 4718 <sup>1</sup> | 4767 | 4718 <sup>1</sup> | 4767 |
| 2285-2439 | x 2137-2286 | -                 | 3769 | -                 | -    | -                 | -    | -                 | -    |
| 2285-2439 | x 2287-2439 | -                 | 3914 | -                 | -    | -                 | -    | -                 | -    |
| 2440-2744 | x 1931-1981 | -                 | 3922 | -                 | -    | -                 | -    | -                 | -    |
| 2440-2744 | x 1982-2136 | -                 | 3948 | -                 | -    | -                 | -    | -                 | -    |
| 2440-2744 | x 2137-2286 | -                 | 4282 | -                 | -    | -                 | -    | -                 | -    |
| 2440-2744 | x 2287-2439 | -                 | 4400 | -                 | -    | -                 | -    | -                 | -    |
| 2745-3049 | x 1931-1981 | -                 | 4490 | -                 | -    | -                 | -    | -                 | -    |
| 2745-3049 | x 1982-2136 | -                 | 4536 | -                 | -    | -                 | -    | -                 | -    |

<sup>1</sup> These doors are not available over 2438 mm wide.

### Single door

Nominal Door Size  
Width x Height  
(mm x mm)

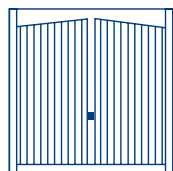

Barrington

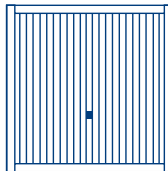

Kingsbury

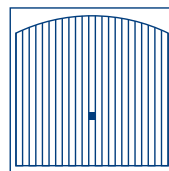

Adlington



Ashton<sup>2</sup>

|           |             | Barrington        |      | Kingsbury         |      | Adlington         |      | Ashton <sup>2</sup> |      |
|-----------|-------------|-------------------|------|-------------------|------|-------------------|------|---------------------|------|
|           |             | C                 | R    | C                 | R    | C                 | R    | C                   | R    |
| 1930-1984 | x 1931-1981 | 3873              | 3922 | 3846              | 3895 | 3305              | 3354 | 4498                | 4547 |
| 1930-1984 | x 1982-2136 | 3896              | 3945 | 3872              | 3921 | 3328              | 3377 | 4522                | 4571 |
| 1930-1984 | x 2137-2286 | -                 | 4286 | -                 | 4250 | -                 | 3696 | -                   | 4902 |
| 1930-1984 | x 2287-2439 | -                 | 4366 | -                 | 4343 | -                 | 3779 | -                   | 4995 |
| 1985-2284 | x 1931-1981 | 4012              | 4061 | 3988              | 4037 | 3449              | 3498 | 4641                | 4690 |
| 1985-2284 | x 1982-2136 | 4040              | 4089 | 4009              | 4058 | 3473              | 3522 | 4663                | 4712 |
| 1985-2284 | x 2137-2286 | -                 | 4423 | -                 | 4386 | -                 | 3819 | -                   | 5038 |
| 1985-2284 | x 2287-2439 | -                 | 4500 | -                 | 4478 | -                 | 3897 | -                   | 5130 |
| 2285-2439 | x 1931-1981 | 4143 <sup>1</sup> | 4192 | 4112 <sup>1</sup> | 4161 | 3616 <sup>1</sup> | 3665 | 4766                | 4815 |
| 2285-2439 | x 1982-2136 | 4166 <sup>1</sup> | 4215 | 4140 <sup>1</sup> | 4189 | 3640 <sup>1</sup> | 3689 | 4794                | 4843 |
| 2285-2439 | x 2137-2286 | -                 | 4538 | -                 | 4499 | -                 | 4016 | -                   | 5154 |
| 2285-2439 | x 2287-2439 | -                 | 4651 | -                 | 4627 | -                 | 4156 | -                   | 5280 |
| 2440-2744 | x 1931-1981 | -                 | 4689 | -                 | 4543 | -                 | 4168 | -                   | 5196 |
| 2440-2744 | x 1982-2136 | -                 | 4722 | -                 | 4577 | -                 | 4187 | -                   | 5227 |
| 2440-2744 | x 2137-2286 | -                 | 5078 | -                 | 4931 | -                 | 4529 | -                   | 5582 |
| 2440-2744 | x 2287-2439 | -                 | 5190 | -                 | 5045 | -                 | 4643 | -                   | 5697 |
| 2745-3049 | x 1931-1981 | -                 | 5262 | -                 | 5115 | -                 | 4736 | -                   | 5768 |
| 2745-3049 | x 1982-2136 | -                 | 5307 | -                 | 5156 | -                 | 4776 | -                   | 5807 |

<sup>1</sup> These doors are not available over 2438 mm wide.

<sup>2</sup> Ashton doors may have cross bracing and / or locking rods behind the windows depending upon the size and gear type.

Orders for purpose made sizes will only be accepted as nominal door size for unframed version and overall frame size when ordering a framed version. Orders for purpose made framed doors will not be accepted as nominal door size. For further options please see page 35.

## Single door

Nominal Door Size  
Width x Height  
(mm x mm)

Shaftesbury

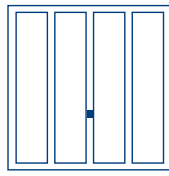

Grantham

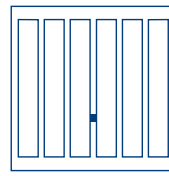

Seymour

|           |             | Shaftesbury       |      | Grantham          |      | Seymour           |      |
|-----------|-------------|-------------------|------|-------------------|------|-------------------|------|
|           |             | C                 | R    | C                 | R    | C                 | R    |
| 1930-1984 | x 1931-1981 | 3334              | 3383 | 2799              | 2848 | 3334              | 3383 |
| 1930-1984 | x 1982-2136 | 3360              | 3409 | 2824              | 2873 | 3360              | 3409 |
| 1930-1984 | x 2137-2286 | -                 | 3596 | -                 | 3064 | -                 | 3596 |
| 1930-1984 | x 2287-2439 | -                 | 3709 | -                 | 3174 | -                 | 3709 |
| 1985-2284 | x 1931-1981 | 3397              | 3446 | 2865              | 2914 | 3397              | 3446 |
| 1985-2284 | x 1982-2136 | 3426              | 3475 | 2892              | 2941 | 3426              | 3475 |
| 1985-2284 | x 2137-2286 | -                 | 3645 | -                 | 3114 | -                 | 3645 |
| 1985-2284 | x 2287-2439 | -                 | 3753 | -                 | 3221 | -                 | 3753 |
| 2285-2439 | x 1931-1981 | 3454 <sup>1</sup> | 3503 | 2922 <sup>1</sup> | 2971 | 3454 <sup>1</sup> | 3503 |
| 2285-2439 | x 1982-2136 | 3477 <sup>1</sup> | 3526 | 2942 <sup>1</sup> | 2991 | 3477 <sup>1</sup> | 3526 |
| 2285-2439 | x 2137-2286 | -                 | 3674 | -                 | 3140 | -                 | 3674 |
| 2285-2439 | x 2287-2439 | -                 | 3832 | -                 | 3295 | -                 | 3832 |
| 2440-2744 | x 1931-1981 | -                 | 4112 | -                 | 3579 | -                 | 4112 |
| 2440-2744 | x 1982-2136 | -                 | 4143 | -                 | 3611 | -                 | 4143 |
| 2440-2744 | x 2137-2286 | -                 | 4301 | -                 | 3769 | -                 | 4301 |
| 2440-2744 | x 2287-2439 | -                 | 4423 | -                 | 3885 | -                 | 4423 |
| 2745-3049 | x 1931-1981 | -                 | 4601 | -                 | 4068 | -                 | 4601 |
| 2745-3049 | x 1982-2136 | -                 | 4602 | -                 | 4069 | -                 | 4602 |

<sup>1</sup> These doors are not available over 2438 mm wide.

## Single door

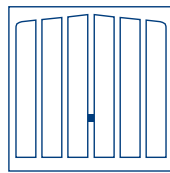
Nominal Door Size  
Width x Height  
(mm x mm)

Tudor

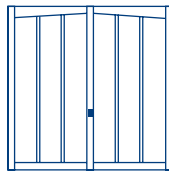

Bosworth

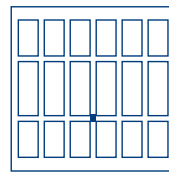

Wolsey



|           |             | Tudor             |      | Bosworth          |      | Wolsey            |      |
|-----------|-------------|-------------------|------|-------------------|------|-------------------|------|
|           |             | C                 | R    | C                 | R    | C                 | R    |
| 1930-1984 | x 1931-1981 | 3477              | 3526 | 3516              | 3565 | 3471              | 3520 |
| 1930-1984 | x 1982-2136 | 3497              | 3546 | 3542              | 3591 | 3494              | 3543 |
| 1930-1984 | x 2137-2286 | -                 | 3735 | -                 | 3778 | -                 | 3730 |
| 1930-1984 | x 2287-2439 | -                 | 3846 | -                 | 3891 | -                 | 3853 |
| 1985-2284 | x 1931-1981 | 3541              | 3590 | 3582              | 3631 | 3537              | 3586 |
| 1985-2284 | x 1982-2136 | 3567              | 3616 | 3605              | 3654 | 3559              | 3608 |
| 1985-2284 | x 2137-2286 | -                 | 3785 | -                 | 3830 | -                 | 3779 |
| 1985-2284 | x 2287-2439 | -                 | 3896 | -                 | 3939 | -                 | 3905 |
| 2285-2439 | x 1931-1981 | 3594 <sup>1</sup> | 3643 | 3632 <sup>1</sup> | 3681 | 3588 <sup>1</sup> | 3637 |
| 2285-2439 | x 1982-2136 | 3616 <sup>1</sup> | 3665 | 3658 <sup>1</sup> | 3707 | 3614 <sup>1</sup> | 3663 |
| 2285-2439 | x 2137-2286 | -                 | 3815 | -                 | 3851 | -                 | 3812 |
| 2285-2439 | x 2287-2439 | -                 | 4029 | -                 | 4069 | -                 | 3981 |
| 2440-2744 | x 1931-1981 | -                 | 4286 | -                 | 4324 | -                 | 4184 |
| 2440-2744 | x 1982-2136 | -                 | 4314 | -                 | 4358 | -                 | 4215 |
| 2440-2744 | x 2137-2286 | -                 | 4500 | -                 | 4546 | -                 | 4374 |
| 2440-2744 | x 2287-2439 | -                 | 4618 | -                 | 4661 | -                 | 4490 |
| 2745-3049 | x 1931-1981 | -                 | 4781 | -                 | 4824 | -                 | 4643 |
| 2745-3049 | x 1982-2136 | -                 | 4824 | -                 | 4863 | -                 | 4646 |

<sup>1</sup> These doors are not available over 2438 mm wide.

Orders for purpose made sizes will only be accepted as nominal door size for unframed version and overall frame size when ordering a framed version. Orders for purpose made framed doors will not be accepted as nominal door size.

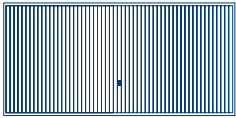
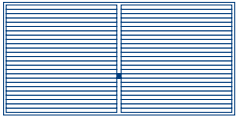
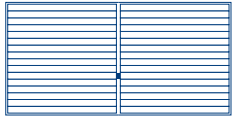
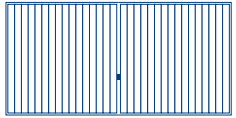
For further options please see page 35.

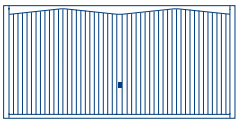
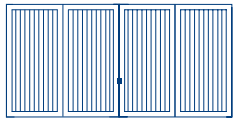
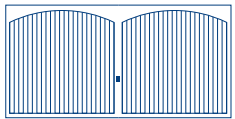
| Double door                                      |              |  |  |  |  |
|--|--------------|---|---|--|---|
| Nominal Door Size<br>Width x Height<br>(mm x mm) | Size<br>Code | Vertical Timber   | Horizontal Timber   | Countryman   | Hampton   |
|  |              | R   | R   | R  | R   |
| 3049 x 2286                                      | 1076         | 4852  | 4915  | 6281   | 6281  |
| 3354 x 1981                                      | 1166         | 4852  | 4916  | 6218   | 6218  |
| 3354 x 2136                                      | 1170         | 4988  | 5056  | 6350   | 6350  |
| 3354 x 2286                                      | 1176         | 5394  | 5465  | 6886   | 6886  |
| 3659 x 1981                                      | 1266         | 5467  | 5542  | 6920   | 6920  |
| 3659 x 2136                                      | 1270         | 5609  | 5679  | 7054   | 7054  |
| 3659 x 2286                                      | 1276         | 6102  | 6182  | 7703   | 7703  |
| 3964 x 1981                                      | 1366         | 6463  | 6556  | 7625   | 7625  |
| 3964 x 2136                                      | 1370         | 6667  | 6759  | 7831   | 7831  |
| 3964 x 2286                                      | 1376         | 7235  | 7331  | 8515   | 8515  |
| 4269 x 1981                                      | 1466         | 6324  | 6417  | 7854   | 7854  |
| 4269 x 2136                                      | 1470         | 6463  | 6556  | 7989   | 7989  |
| 4574 x 1981                                      | 1566         | 7141  | 7240  | -  | -   |
| 4574 x 2136                                      | 1570         | 7345  | 7439  | -  | -   |
| 4879 x 1981                                      | 1666         | 7788  | 7892  | -  | -   |
| 4879 x 2136                                      | 1670         | 7855  | 7959  | -  | -   |

| Double door                                      |              |  |  |  |  |
|--|--------------|---|---|--|---|
| Nominal Door Size<br>Width x Height<br>(mm x mm) | Size<br>Code | Barrington  | Kingsbury   | Adlington  | Ashton <sup>1</sup>   |
|  |              | R   | R   | R  | R   |
| 3049 x 2286                                      | 1076         | 5771  | 5504  | 5390   | 6412  |
| 3354 x 1981                                      | 1166         | 5728  | 5489  | 5287   | 6222  |
| 3354 x 2136                                      | 1170         | 5864  | 5625  | 5417   | 6357  |
| 3354 x 2286                                      | 1176         | 6357  | 6096  | 5871   | 6891  |
| 3659 x 1981                                      | 1266         | 6377  | 6135  | 5854   | 7146  |
| 3659 x 2136                                      | 1270         | 6514  | 6273  | 5987   | 7283  |
| 3659 x 2286                                      | 1276         | 7110  | 6876  | 6528   | 7956  |
| 3964 x 1981                                      | 1366         | 7420  | 7262  | 7086   | 8382  |
| 3964 x 2136                                      | 1370         | 7625  | 7465  | 7292   | 8588  |
| 3964 x 2286                                      | 1376         | 8288  | 8116  | 7925   | 9345  |
| 4269 x 1981                                      | 1466         | 7283  | 7127  | 6951   | 8247  |
| 4269 x 2136                                      | 1470         | 7420  | 7262  | 7086   | 8382  |
| 4574 x 1981                                      | 1566         | 8095  | 7992  | -  | 9088  |
| 4574 x 2136                                      | 1570         | 8300  | 8196  | -  | 9289  |
| 4879 x 1981                                      | 1666         | 8741  | 8641  | -  | 9840  |
| 4879 x 2136                                      | 1670         | 8813  | 8710  | -  | 9905  |

<sup>1</sup> Ashton doors may have cross bracing and/or locking rods behind the windows depending upon the size and gear type.

For further options please see page 35.

**Double door**

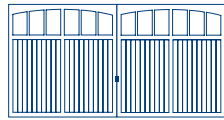
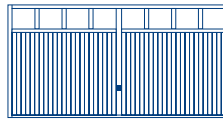
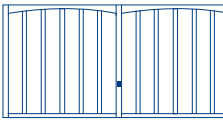
| Nominal Door Size<br>Width x Height<br>(mm x mm) | Size<br>Code |  |  |  |
|--|--------------|---|---|--|
|  |              | Rochdale <sup>1,2</sup>   | Sandhurst <sup>1</sup>  | Shaftesbury  |
|  |              | R   | R   | R  |
| 3049 x 2286                                      | 1076         | 6782  | 5962  | 4687   |
| 3354 x 1981                                      | 1166         | 6560  | 5923  | 4627   |
| 3354 x 2136                                      | 1170         | 6698  | 6059  | 4763   |
| 3354 x 2286                                      | 1176         | 7269  | 6572  | 5145   |
| 3659 x 1981                                      | 1266         | 7484  | 6682  | 5135   |
| 3659 x 2136                                      | 1270         | 7625  | 6819  | 5270   |
| 3659 x 2286                                      | 1276         | 8328  | 7439  | 5735   |
| 3964 x 1981                                      | 1366         | 8725  | 7799  | 5980   |
| 3964 x 2136                                      | 1370         | 8931  | 7999  | 6183   |
| 3964 x 2286                                      | 1376         | 9714  | 8704  | 6698   |
| 4269 x 1981                                      | 1466         | 8588  | 7658  | 5844   |
| 4269 x 2136                                      | 1470         | 8725  | 7799  | 5980   |
| 4574 x 1981                                      | 1566         | 9720  | 8710  | 6698   |
| 4574 x 2136                                      | 1570         | 9925  | 8917  | 6901   |
| 4879 x 1981                                      | 1666         | 10384   | 9663  | 7446   |
| 4879 x 2136                                      | 1670         | 10450   | 9735  | 7518   |

<sup>1</sup> Rochdale and Sandhurst doors may have cross bracing and/or locking rods behind the windows depending upon the size and gear type.

<sup>2</sup> Rochdale doors up to 3659 mm wide will be manufactured with one arch not the two as shown above.

**Double door**

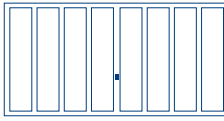
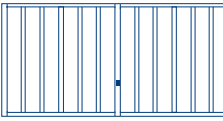
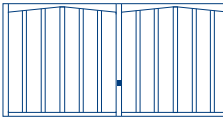
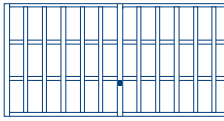
| Nominal Door Size<br>Width x Height<br>(mm x mm) | Size<br>Code |  |  |  |  |
|--|--------------|---|---|--|---|
|  |              | Grantham  | Seymour   | Tudor  | Wolsey  |
|  |              | R   | R   | R  | R   |
| 3049 x 2286                                      | 1076         | 4102  | 4640  | 4687   | 5262  |
| 3354 x 1981                                      | 1166         | 4017  | 4492  | 4627   | 5208  |
| 3354 x 2136                                      | 1170         | 4152  | 4627  | 4763   | 5345  |
| 3354 x 2286                                      | 1176         | 4474  | 4995  | 5145   | 5728  |
| 3659 x 1981                                      | 1266         | 4541  | 5069  | 5135   | 5716  |
| 3659 x 2136                                      | 1270         | 4678  | 5202  | 5270   | 5854  |
| 3659 x 2286                                      | 1276         | 5083  | 5665  | 5735   | 6313  |
| 3964 x 1981                                      | 1366         | 5083  | 5909  | 5980   | 6561  |
| 3964 x 2136                                      | 1370         | 5287  | 6115  | 6183   | 6766  |
| 3964 x 2286                                      | 1376         | 5707  | 6628  | 6698   | 7277  |
| 4269 x 1981                                      | 1466         | 4945  | 5771  | 5844   | 6425  |
| 4269 x 2136                                      | 1470         | 5083  | 5909  | 5980   | 6561  |
| 4574 x 1981                                      | 1566         | -   | -   | 6698   | 7277  |
| 4574 x 2136                                      | 1570         | -   | -   | 6901   | 7480  |
| 4879 x 1981                                      | 1666         | -   | -   | 7446   | 8030  |
| 4879 x 2136                                      | 1670         | -   | -   | 7518   | 8095  |

For further options please see page 35.



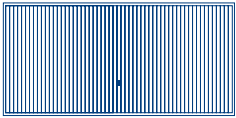
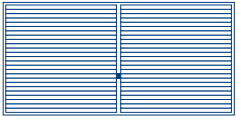
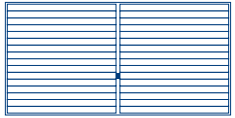
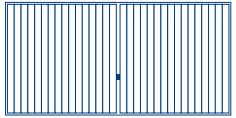

### Double door

Nominal Door Size  
Width x Height  
(mm x mm)

|                       |  |  |  |  |
|-----------------------|---|---|--|---|
|                       | Vertical Timber   | Horizontal Timber   | Countryman   | Hampton   |
|                       | R   | R   | R  | R   |
| 2745-3049 x 2137-2286 | -   | -   | -  | -   |
| 3050-3659 x 1931-1981 | 6014  | 6096  | 7382   | 7382  |
| 3050-3659 x 1982-2136 | 6164  | 6246  | 7529   | 7529  |
| 3050-3659 x 2137-2286 | 6710  | 6801  | 8225   | 8225  |
| 3660-4269 x 1931-1981 | 7331  | 7434  | 8744   | 8744  |
| 3660-4269 x 1982-2136 | 7562  | 7658  | 8968   | 8968  |
| 3660-4269 x 2137-2286 | 7937  | 8043  | 9417   | 9417  |
| 4270-5000 x 1931-1981 | 8568  | 8678  | -  | -   |
| 4270-5000 x 1982-2136 | 8641  | 8753  | -  | -   |

### Double door

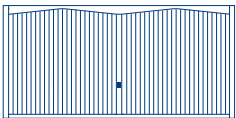
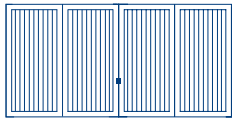
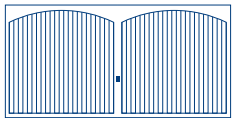
Nominal Door Size  
Width x Height  
(mm x mm)

|                       |  |  |  |  |
|-----------------------|---|---|--|---|
|                       | Barrington  | Kingsbury   | Adlington  | Ashton <sup>1</sup>   |
|                       | R   | R   | R  | R   |
| 2745-3049 x 2137-2286 | -   | -   | -  | 7045  |
| 3050-3659 x 1931-1981 | 7012  | 6752  | 6432   | 7858  |
| 3050-3659 x 1982-2136 | 7163  | 6901  | 6583   | 8009  |
| 3050-3659 x 2137-2286 | 7818  | 7562  | 7175   | 8744  |
| 3660-4269 x 1931-1981 | 8386  | 8218  | 8022   | 9445  |
| 3660-4269 x 1982-2136 | 8611  | 8440  | 8246   | 9668  |
| 3660-4269 x 2137-2286 | 9041  | 8858  | 8657   | 10151   |
| 4270-5000 x 1931-1981 | 9617  | 9506  | -  | 10817   |
| 4270-5000 x 1982-2136 | 9696  | 9579  | -  | 10892   |

<sup>1</sup> Ashton doors may have cross bracing and/or locking rods behind the windows depending upon the size and gear type.

Orders for purpose made sizes will only be accepted as nominal door size for unframed version and overall frame size when ordering a framed version. Orders for purpose made framed doors will not be accepted as nominal door size.

For further options please see page 35.

**Double door**

Nominal Door Size  
Width x Height  
(mm x mm)

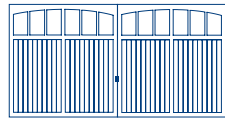

Rochdale<sup>1,2</sup>

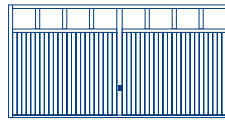

Sandhurst<sup>1</sup>

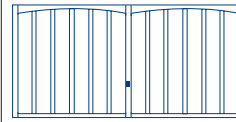

Shaftesbury

|                       | R     | R     | R    |
|-----------------------|-------|-------|------|
| 2745-3049 x 2137-2286 | 7460  | 6556  | 5146 |
| 2745-3049 x 2287-2439 | 7838  | 6883  | 5409 |
| 3050-3659 x 1931-1981 | 8235  | 7351  | 5646 |
| 3050-3659 x 1982-2136 | 8386  | 7501  | 5796 |
| 3050-3659 x 2137-2286 | 9159  | 8183  | 6308 |
| 3050-3659 x 2287-2439 | 9612  | 8591  | 6622 |
| 3660-4269 x 1931-1981 | 9822  | 8800  | 6802 |
| 3660-4269 x 1982-2136 | 10046 | 9024  | 7029 |
| 3660-4269 x 2137-2286 | 10547 | 9473  | 7381 |
| 3660-4269 x 2287-2439 | 11049 | 9925  | 7728 |
| 4270-5000 x 1931-1981 | 11421 | 10632 | 8190 |
| 4270-5000 x 1982-2136 | 11494 | 10705 | 8267 |

<sup>1</sup> Rochdale and Sandhurst doors may have cross bracing and/or locking rods behind the windows depending upon the size and gear type.

<sup>2</sup> Rochdale doors up to 3659 mm wide will be manufactured with one arch not the two as shown above.

**Double door**

Nominal Door Size  
Width x Height  
(mm x mm)

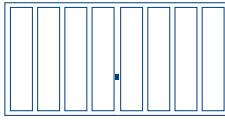

Grantham

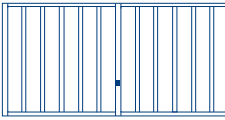

Seymour

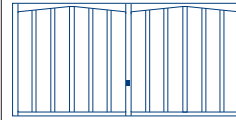

Tudor

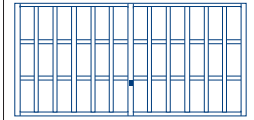



Wolsey

|                       | R    | R    | R    | R    |
|-----------------------|------|------|------|------|
| 2745-3049 x 2137-2286 | 4510 | 5103 | 5146 | 5729 |
| 2745-3049 x 2287-2439 | 4737 | 5360 | 5409 | 5988 |
| 3050-3659 x 1931-1981 | 4989 | 5570 | 5646 | 6227 |
| 3050-3659 x 1982-2136 | 5143 | 5721 | 5796 | 6377 |
| 3050-3659 x 2137-2286 | 5585 | 6233 | 6308 | 6886 |
| 3050-3659 x 2287-2439 | 5864 | 6543 | 6622 | 7197 |
| 3660-4269 x 1931-1981 | 5810 | 6725 | 6802 | 7384 |
| 3660-4269 x 1982-2136 | 6034 | 6954 | 7029 | 7604 |
| 3660-4269 x 2137-2286 | 6340 | 7300 | 7381 | 7959 |
| 3660-4269 x 2287-2439 | 6641 | 7648 | 7728 | 8309 |
| 4270-5000 x 1931-1981 | -    | -    | 8190 | 8770 |
| 4270-5000 x 1982-2136 | -    | -    | 8267 | 8844 |

Orders for purpose made sizes will only be accepted as nominal door size for unframed version and overall frame size when ordering a framed version. Orders for purpose made framed doors will not be accepted as nominal door size.

For further options please see page 35.

| Timber door window options<br>Prices in £ stated per door |  |              |  |              |  |              |
|---|---|--------------|---|--------------|---|--------------|
|   | Standard  |              | Georgian <sup>1</sup>   |              | Diagonal <sup>1</sup>   |              |
|   | Single doors  | Double doors | Single doors  | Double doors | Single doors  | Double doors |
| Plain   | no on-cost  | no on-cost   | 170   | 235          | 170   | 235          |
| Crystal   | no on-cost  | no on-cost   | 170   | 235          | 170   | 235          |

<sup>1</sup> Only available on Sandhurst.

Windows are manufactured from 4 mm acrylic panes. Please state on order if clear or stippled panes required.

| Options  | Single doors | Double doors |
|--|--------------|--------------|
|  | add          | add          |
| Factory pre-framed standard single doors   | 178          | -            |
| Steel frame for standard double doors  | -            | 267          |
| Factory pre-framed purpose-made single doors   | 201          | -            |
| Steel frame for purpose-made double doors  | -            | 297          |
| Additional Lock Kit, C-type/ R-type (fitted onto door)   | 83           | -            |
| Factory fully finished stain in Light Oak, Antique Oak, Mahogany, Walnut, Chestnut and Ebony   | 232          | 343          |
| Factory white primer ready for on-site painting  | 314          | 479          |
| Factory fully finished painting (any RAL colour timber only)   | 519          | 900          |
| Diecast metal handles with matching base plates: brass effect, chrome effect, brushed steel and white  | 124          | 124          |
| Bottom weatherseal, 2405 mm length (suitable for gaps up to 15 mm between the door and the floor level)  | 61           | 61           |
| Bottom weatherseal, 3000 mm length (suitable for gaps up to 15 mm between the door and the floor level)  | 67           | 67           |
| Surcharge for colour steel Chassis and/or frame finished in RAL colour (no additional charge for Brown RAL8028 or White RAL9016 chassis and frame) | 176          | 275          |

Please note, retractable plus lifting gear is not available on timber up and over garage doors.

# Steel and Timber Garage Side Doors

## Surface

Steel doors constructed around a strong steel box section chassis in Traffic White (RAL 9016) as standard. Timber doors constructed using timber, built around a strong steel box section chassis. A range of stain options are available.







## Handle

Supplied with lever/lever handle on left side (viewed outside)

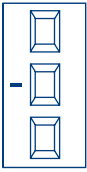
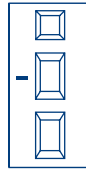
## Terminology

Nominal Door Size: This is the actual door panel size plus the fitting tolerances. The nominal door size should be used for internal dimensions of a timber frame.

Size Code: This has traditionally been used to order doors. This may not be the actual door size.



| Steel door - standard sizes                      |   |           |  |  |  |  |  |  |  |
|--|---|-----------|---|---|---|--|---|---|---|
| Nominal Door Size<br>Width x Height<br>(mm x mm) | Overall frame size<br>(between fix) <sup>1</sup><br>Width x Height<br>(mm x mm) | Size Code | Georgian  | Beaumont  | Cathedral   | Beaumont with Windows <sup>2</sup>   | Carlton   | Ascot   | Windsor   |
| 732 x 1905                                       | 882 x 1991  | 2664      | 1094  | 1094  | 1094  | 1206   | 905   | 1094  | 1094  |
| 732 x 1955                                       | 882 x 2041  | 2666      | 1115  | 1115  | 1115  | 1225   | 924   | 1115  | 1115  |
| 732 x 2110                                       | 882 x 2196  | 2670      | 1142  | 1142  | 1142  | 1254   | 950   | 1142  | 1142  |
| 884 x 1905                                       | 1034 x 1991   | 3064      | 1133  | 1133  | 1133  | 1244   | 940   | 1133  | 1133  |
| 884 x 1955                                       | 1034 x 2041   | 3066      | 1154  | 1154  | 1154  | 1262   | 962   | 1154  | 1154  |
| 884 x 2110                                       | 1034 x 2196   | 3070      | 1183  | 1183  | 1183  | 1295   | 992   | 1183  | 1183  |
| 1037 x 1905                                      | 1187 x 1991   | 3664      | 1171  | 1171  | 1171  | 1284   | 979   | 1171  | 1171  |
| 1037 x 1955                                      | 1187 x 2041   | 3666      | 1194  | 1194  | 1194  | 1301   | 1001  | 1194  | 1194  |
| 1037 x 2110                                      | 1187 x 2196   | 3670      | 1218  | 1218  | 1218  | 1332   | 1028  | 1218  | 1218  |
| 1170 x 1905                                      | 1320 x 1991   | 4064      | 1210 <sup>3</sup>   | 1210 <sup>3</sup>   | 1210 <sup>3</sup>   | 1318 <sup>3</sup>  | 1017  | 1210  | 1210  |
| 1170 x 1955                                      | 1320 x 2041   | 4066      | 1228 <sup>3</sup>   | 1228 <sup>3</sup>   | 1228 <sup>3</sup>   | 1340 <sup>3</sup>  | 1039  | 1228  | 1228  |
| 1170 x 2110                                      | 1320 x 2196   | 4070      | 1241 <sup>3</sup>   | 1241 <sup>3</sup>   | 1241 <sup>3</sup>   | 1351 <sup>3</sup>  | 1064  | 1241  | 1241  |

<sup>1</sup> No fitting clearance allowed.

<sup>2</sup> Windows for Beaumont: Standard () , Diamond () , Cross () . Please state on order if plain or crystal panes.

<sup>3</sup> Doors over 1210 mm overall frame width have two vertical columns of panel pressings. These doors vary from images shown.

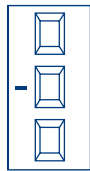
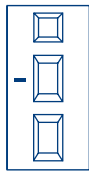
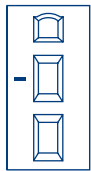
### Steel door - purpose-made sizes

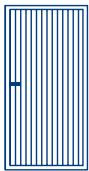
| Nominal Door Size<br>Width x Height<br>(mm x mm) | Overall frame size<br>(between fix) <sup>1</sup><br>Width x Height<br>(mm x mm) |  |  |  |  |  |
|--|---|---|---|---|---|---|
|  |   | Georgian <sup>3</sup>   | Beaumont <sup>3</sup>   | Cathedral <sup>3</sup>  | Beaumont<br>with<br>Windows <sup>2,3</sup>  | Carlton   |
| 670-1036 x 1905-2110                             | 820-1186 x 1991-2196  | 1363 <sup>4</sup>   | 1363 <sup>4</sup>   | 1363 <sup>4</sup>   | 1519 <sup>4</sup>   | 1194  |
| 1037-1310 x 1905-2110                            | 1187-1320 x 1991-2196   | 1440  | 1440  | 1440  | 1594  | 1266  |

<sup>1</sup> No fitting clearance allowed.



<sup>2</sup> Windows for Beaumont: Standard , Diamond , Cross . Please state on order if plain or crystal panes.

<sup>3</sup> Purpose-made Georgian, Beaumont and Cathedral models have two panel pressings on door design when overall frame width is over 1210 mm.

<sup>4</sup> Cathedral, Beaumont and Georgian are available at a minimum overall frame size of 882 mm.

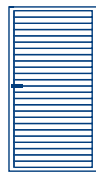
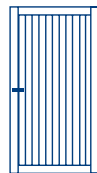

All doors come factory pre-framed, right hand hinged with the handle on the left as standard (viewed from outside).  
Supplied with lever/lever handle set. Doors only available to open outwards.

### Timber door - standard sizes

| Nominal Door Size<br>Width x Height<br>(mm x mm) | Overall frame size<br>(between fix) <sup>1</sup><br>Width x Height<br>(mm x mm) | Size<br>Code |  |  |  |  |
|--|---|--------------|---|---|---|---|
|  |   |              | Vertical<br>Timber  | Horizontal<br>Timber  | Kingsbury   | Seymour   |
| 732 x 1905                                       | 882 x 1991  | 2664         | 2653  | 2717  | 2884  | 2653  |
| 732 x 1955                                       | 882 x 2041  | 2666         | 2688  | 2750  | 2912  | 2688  |
| 732 x 2110                                       | 882 x 2196  | 2670         | 2735  | 2791  | 2954  | 2735  |
| 884 x 1905                                       | 1034 x 1991   | 3064         | 2750  | 2807  | 2968  | 2750  |
| 884 x 1955                                       | 1034 x 2041   | 3066         | 2777  | 2835  | 3001  | 2777  |
| 884 x 2110                                       | 1034 x 2196   | 3070         | 2822  | 2884  | 3041  | 2822  |
| 1037 x 1905                                      | 1187 x 1991   | 3664         | 2835  | 2895  | 3064  | 2835  |
| 1037 x 1955                                      | 1187 x 2041   | 3666         | 2865  | 2928  | 3089  | 2865  |
| 1037 x 2110                                      | 1187 x 2196   | 3670         | 2912  | 2968  | 3133  | 2912  |
| 1170 x 1905                                      | 1320 x 1991   | 4064         | 2928  | 2983  | 3146  | 2928  |
| 1170 x 1955                                      | 1320 x 2041   | 4066         | 2954  | 3017  | 3180  | 2954  |
| 1170 x 2110                                      | 1320 x 2196   | 4070         | 3001  | 3064  | 3217  | 3001  |

<sup>1</sup> No fitting clearance allowed.

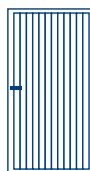
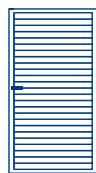
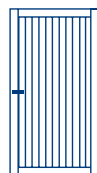
### Timber door - purpose-made sizes

| Nominal Door Size<br>Width x Height<br>(mm x mm) | Overall frame size<br>(between fix) <sup>1</sup><br>Width x Height<br>(mm x mm) |  |  |  |  |
|--|---|---|---|---|---|
|  |   | Vertical<br>Timber  | Horizontal<br>Timber  | Kingsbury <sup>2</sup>  | Seymour   |
| 670-1036 x 1905-2110                             | 820-1186 x 1991-2196  | 3206  | 3268  | 3428  | 3206  |
| 1037-1310 x 1905-2110                            | 1187-1320 x 1991-2196   | 3384  | 3443  | 3601  | 3384  |

<sup>1</sup> No fitting clearance allowed.

<sup>2</sup> Minimum overall frame width for Kingsbury is 826 mm.

# Steel, Timber and GRP Side-hinged Doors

## Surface

Steel Side-hinged doors are constructed around a strong steel box section chassis in Traffic White (RAL 9016) as standard. Timber doors constructed using timber, built around our steel box section chassis. A range of stain options are available.

## Pre-Framed Design and Concealed Hinges

All doors come factory pre-framed with 75mm wide door frame and right-hand door leaf leading as standard. Hinges are concealed in the frame, with no hinge knuckles protruding above the surface of the door.

## Two-Point Locking

A shoot bolt latch is used to secure the fixed door leaf at the top and bottom.

## Door Stays and Gas Pistons

Supplied complete with solid metal door stays and pull cord release. Gas pistons are fitted to each door leaf for a controlled closing motion.

## Rubber weather seals

Sturdy rubber weather seals all built into the door frame and along the door stop on the fixed and leading door leaf.

## Aluminium threshold

A 20 mm aluminium threshold is supplied as standard at the base of the door.

## Steel Colours

Standard colours are:

- Traffic White (RAL 9016)

Optional colours available on an approximate 4 week lead-time:

- |                          |                              |                          |                             |
|--------------------------|------------------------------|--------------------------|-----------------------------|
| - Light Ivory (RAL 1015) | - Moss Green (RAL 6005)      | - Light grey (RAL 7035)  | - Burgundy Brown            |
| - Ruby Red (RAL 3003)    | - Fir Green (RAL 6009)       | - Agate Grey (RAL 7038)  | - Golden Brown              |
| - Signal Blue (RAL 5005) | - Slate Grey (RAL 7015)      | - Window Grey (RAL 7040) | - Chartwell Green (BS 4800) |
| - Steel Blue (RAL 5011)  | - Anthracite Grey (RAL 7016) | - Terra Brown (RAL 8028) |                             |
| - Pigeon Blue (RAL 5014) | - Stone Grey (RAL 7030)      | - Jet Black (RAL 9005)   |                             |

## Timber Stains

Full finished stains available as an option. Stain colours include Light Oak, Antique Oak, Mahogany, Walnut, Chestnut and Ebony

## GRP Colours

White, Magnolia, Bleached Oak, Red Mahogany, Dark Mahogany, Light Oak, Dark Oak, Irish Oak, Honey Beech, Teak, Rosewood, Golden Brown, Ebony, Anthracite Grey, Green, Blue, Gloss White and Gloss Magnolia.

## Handle

Supplied with black lever/ lever handle on right side (viewed outside) and centrally located flip-up handle which releases shoot-bolt latches at the top and bottom of the fixed leaf (viewed inside).

## Terminology

Nominal Door Size: This is the actual door panel size plus the fitting tolerances. The nominal door size should be used for internal dimensions of a timber frame.

Size Code: This has traditionally been used to order doors. This may not be the actual door size.



## Packaging

All doors are supplied wrapped. Only steel doors are supplied unwrapped as standard with optional poly-wrapping available.

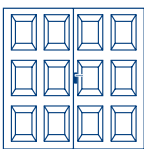
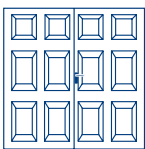
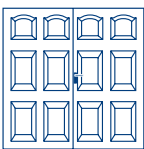
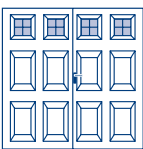
### Steel door - standard sizes

| Nominal Door Size<br>Width x Height<br>(mm x mm) | Overall frame size<br>(between fix) <sup>1</sup><br>Width x Height<br>(mm x mm) | Size<br>Code |  |  |  |  |
|--|---|--------------|---|---|--|---|
|  |   |              | Georgian  | Beaumont  | Cathedral  | Beaumont with<br>Windows <sup>2</sup>   |
| 1780 x 1806                                      | 1930 x 1891   | 6060         | -   | -   | -  | -   |
| 1934 x 1806                                      | 2084 x 1891   | 6660         | -   | -   | -  | -   |
| 1934 x 1907                                      | 2084 x 1991   | 6664         | -   | -   | -  | -   |
| 1934 x 1957                                      | 2084 x 2041   | 6666         | -   | -   | -  | -   |
| 1934 x 2112                                      | 2084 x 2196   | 6670         | -   | -   | -  | -   |
| 2084 x 1806                                      | 2234 x 1891   | 7060         | -   | -   | -  | -   |
| 2084 x 1907                                      | 2234 x 1991   | 7064         | 2155  | 2155  | 2155   | 2574  |
| 2084 x 1957                                      | 2234 x 2041   | 7066         | 2155  | 2155  | 2155   | 2574  |
| 2084 x 2112                                      | 2234 x 2196   | 7070         | 2187  | 2187  | 2187   | 2608  |
| 2209 x 1907                                      | 2359 x 1991   | 7564         | 2254  | 2254  | 2254   | 2676  |
| 2209 x 1957                                      | 2359 x 2041   | 7566         | 2254  | 2254  | 2254   | 2676  |
| 2209 x 2112                                      | 2359 x 2196   | 7570         | 2290  | 2290  | 2290   | 2709  |
| 2234 x 1907                                      | 2384 x 1991   | 7664         | 2290  | 2290  | 2290   | 2709  |
| 2234 x 1957                                      | 2384 x 2041   | 7666         | 2290  | 2290  | 2290   | 2709  |
| 2234 x 2112                                      | 2384 x 2196   | 7670         | 2320  | 2320  | 2320   | 2740  |
| 2389 x 1907                                      | 2539 x 1991   | 8064         | 2390  | 2390  | 2390   | 2809  |
| 2389 x 1957                                      | 2539 x 2041   | 8066         | 2390  | 2390  | 2390   | 2809  |
| 2389 x 2112                                      | 2539 x 2196   | 8070         | 2419  | 2419  | 2419   | 2840  |

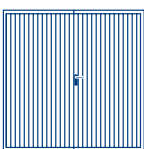
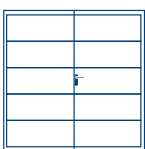
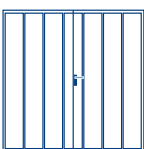
### Steel door - standard sizes

| Nominal Door Size<br>Width x Height<br>(mm x mm) | Overall frame size<br>(between fix) <sup>1</sup><br>Width x Height<br>(mm x mm) | Size<br>Code |  |  |  |  |  |
|--|---|--------------|---|---|--|---|---|
|  |   |              | Carlton   | Ascot   | Windsor  | Salisbury<br>Version 1  | Salisbury<br>Version 2  |
| 1780 x 1806                                      | 1930 x 1891   | 6060         | 1894  | -   | -  | -   | -   |
| 1934 x 1806                                      | 2084 x 1891   | 6660         | 1925  | -   | -  | -   | -   |
| 1934 x 1907                                      | 2084 x 1991   | 6664         | 1958  | -   | -  | -   | -   |
| 1934 x 1957                                      | 2084 x 2041   | 6666         | 1958  | -   | -  | -   | -   |
| 1934 x 2112                                      | 2084 x 2196   | 6670         | 1995  | -   | -  | -   | -   |
| 2084 x 1806                                      | 2234 x 1891   | 7060         | 1995  | -   | -  | -   | -   |
| 2084 x 1907                                      | 2234 x 1991   | 7064         | 2026  | 2155  | 2155   | -   | -   |
| 2084 x 1957                                      | 2234 x 2041   | 7066         | <b>2026</b> <sup>3</sup>  | 2155  | 2155   | 2855  | -   |
| 2084 x 2112                                      | 2234 x 2196   | 7070         | <b>2059</b> <sup>3</sup>  | 2187  | 2187   | 2855  | -   |
| 2209 x 1907                                      | 2359 x 1991   | 7564         | 2126  | 2254  | 2254   | -   | -   |
| 2209 x 1957                                      | 2359 x 2041   | 7566         | 2126  | 2254  | 2254   | -   | -   |
| 2209 x 2112                                      | 2359 x 2196   | 7570         | 2155  | 2290  | 2290   | -   | -   |
| 2234 x 1907                                      | 2384 x 1991   | 7664         | 2155  | 2290  | 2290   | -   | -   |
| 2234 x 1957                                      | 2384 x 2041   | 7666         | 2155  | 2290  | 2290   | -   | 2913  |
| 2234 x 2112                                      | 2384 x 2196   | 7670         | 2187  | 2320  | 2320   | -   | 2913  |
| 2389 x 1907                                      | 2539 x 1991   | 8064         | 2254  | 2390  | 2390   | -   | -   |
| 2389 x 1957                                      | 2539 x 2041   | 8066         | 2254  | 2390  | 2390   | -   | 2913  |
| 2389 x 2112                                      | 2539 x 2196   | 8070         | 2290  | 2419  | 2419   | -   | 2913  |

<sup>1</sup> No fitting clearance allowed.

<sup>2</sup> Windows for Beaumont: Standard , Diamond , Cross . Please state on order if plain or crystal panes.

<sup>3</sup> Carlton 7070 stock door: only available as Traffic White (RAL 9016) with right-hand leading.

All doors come factory pre-framed, right hand door leaf leading as standard (viewed from the outside) with lever/lever handle set.

Ascot, Windsor and Salisbury side-hinged garage doors are only available in 50/ 50 door leaf configuration.

The above doors are shown as 50/50 door leaves configuration. Up to 2234 mm overall frame width these doors are also available as a 1/3 2/3 door configuration. Prices are the same but please be aware panel configurations on Georgian, Beaumont & Cathedral doors will have 3 pressing columns with increased spacing between the pressing (1/3 2/3 is a term used to describe these doors but please note the 1/3 door leaf is always 800 mm wide with the 2/3 element varying to make the desired overall width). 1/3 leaf is always leading.

### Steel door - purpose-made sizes

Overall frame size  
(between fix)<sup>1</sup>  
Width x Height  
(mm x mm)

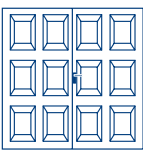
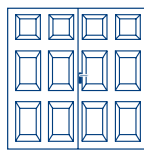
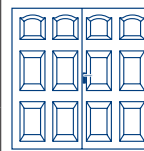
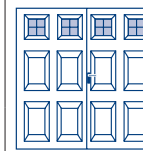
|                           | <br>Georgian | <br>Beaumont | <br>Cathedral | <br>Beaumont with Windows <sup>2</sup> |
|---------------------------|---|---|---|---|
| 1930 - 2234 x 1891 - 2041 | -   | -   | -   | -   |
| 1930 - 2234 x 2042 - 2196 | -   | -   | -   | -   |
| 2235 - 2384 x 1891 - 1990 | -   | -   | -   | -   |
| 2235 - 2384 x 1991 - 2041 | 2402  | 2402  | 2402  | 2922  |
| 2235 - 2384 x 2042 - 2196 | 2427  | 2427  | 2427  | 2946  |
| 2385 - 2539 x 1891 - 1990 | -   | -   | -   | -   |
| 2385 - 2539 x 1991 - 2041 | 2536  | 2536  | 2536  | 3050  |
| 2385 - 2539 x 2042 - 2196 | 2563  | 2563  | 2563  | 3082  |

### Steel door - purpose-made sizes

Overall frame size  
(between fix)<sup>1</sup>  
Width x Height  
(mm x mm)

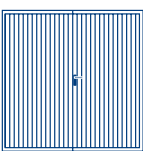
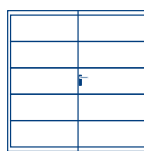
|                           | <br>Carlton | <br>Ascot |
|---------------------------|--|--|
| 1930 - 2234 x 1891 - 2041 | 2143   | -  |
| 1930 - 2234 x 2042 - 2196 | 2198   | -  |
| 2235 - 2384 x 1891 - 1990 | 2223   | -  |
| 2235 - 2384 x 1991 - 2041 | 2290   | 2402   |
| 2235 - 2384 x 2042 - 2196 | 2332   | 2427   |
| 2385 - 2539 x 1891 - 1990 | 2313   | -  |
| 2385 - 2539 x 1991 - 2041 | 2400   | 2536   |
| 2385 - 2539 x 2042 - 2196 | 2429   | 2563   |

<sup>1</sup> No fitting clearance allowed.

<sup>2</sup> Windows for Beaumont: Standard () , Diamond () , Cross () . Please state on order if plain or crystal panes.

All doors come factory pre-framed, right hand door leaf leading as standard (viewed from the outside) with lever/lever handle set.

Ascot and Windsor side-hinged garage doors are only available in 50/ 50 door leaf configuration.



The above doors are shown as 50/50 door leaves configuration. Up to 2234 mm overall frame width these doors are also available as a 1/3 2/3 door configuration. Prices are the same but please be aware panel configurations on Georgian, Beaumont & Cathedral doors will have 3 pressing columns with increased spacing between the pressing (1/3 2/3 is a term used to describe these doors but please note the 1/3 door leaf is always 800 mm wide with the 2/3 element varying to make the desired overall width). 1/3 leaf is always leading.

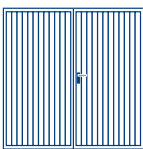
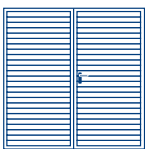
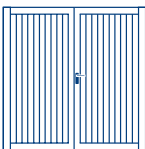
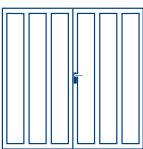
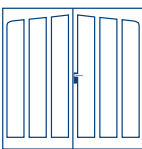

### Timber door - standard sizes

| Nominal Door Size<br>Width x Height<br>(mm x mm) | Overall frame size<br>(between fix) <sup>1</sup><br>Width x Height<br>(mm x mm) | Size<br>Code |  |  |  |  |  |
|--|---|--------------|---|---|--|---|---|
|  |   |              | Vertical<br>Timber <sup>2</sup>   | Horizontal<br>Timber <sup>2</sup>   | Kingsbury <sup>3</sup>   | Seymour <sup>3</sup>  | Tudor <sup>3</sup>  |
| 1780 x 1806                                      | 1930 x 1891   | 6060         | 4353  | 4439  | 4853   | 4131  | 4131  |
| 1934 x 1806                                      | 2084 x 1891   | 6660         | 4407  | 4499  | 4853   | 4186  | 4186  |
| 1934 x 1907                                      | 2084 x 1991   | 6664         | 4407  | 4499  | 4853   | 4186  | 4186  |
| 1934 x 1957                                      | 2084 x 2041   | 6666         | 4448  | 4540  | 4867   | 4228  | 4228  |
| 1934 x 2112                                      | 2084 x 2196   | 6670         | 4448  | 4540  | 4924   | 4228  | 4228  |
| 2084 x 1806                                      | 2234 x 1891   | 7060         | 4520  | 4609  | 4924   | 4298  | 4298  |
| 2084 x 1907                                      | 2234 x 1991   | 7064         | 4534  | 4624  | 4958   | 4312  | 4312  |
| 2084 x 1957                                      | 2234 x 2041   | 7066         | 4550  | 4637  | 5016   | 4323  | 4323  |
| 2084 x 2112                                      | 2234 x 2196   | 7070         | 4550  | 4637  | 5045   | 4323  | 4323  |
| 2209 x 1907                                      | 2359 x 1991   | 7564         | 4587  | 4681  | 5197   | 4372  | 4372  |
| 2209 x 1957                                      | 2359 x 2041   | 7566         | 4600  | 4696  | 5228   | 4383  | 4383  |
| 2209 x 2112                                      | 2359 x 2196   | 7570         | 4629  | 4716  | 5322   | 4407  | 4407  |
| 2234 x 1907                                      | 2384 x 1991   | 7664         | 4587  | 4681  | 5213   | 4372  | 4372  |
| 2234 x 1957                                      | 2384 x 2041   | 7666         | 4600  | 4696  | 5277   | 4383  | 4383  |
| 2234 x 2112                                      | 2384 x 2196   | 7670         | 4629  | 4717  | 5380   | 4407  | 4407  |
| 2389 x 1907                                      | 2539 x 1991   | 8064         | 4768  | 4859  | 5683   | 4550  | 4550  |
| 2389 x 1957                                      | 2539 x 2041   | 8066         | 4780  | 4873  | 5711   | 4563  | 4563  |
| 2389 x 2112                                      | 2539 x 2196   | 8070         | 4799  | 4882  | 5862   | 4573  | 4573  |

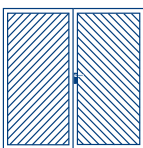
### Timber door - standard sizes

| Nominal Door Size<br>Width x Height<br>(mm x mm) | Overall frame size<br>(between fix) <sup>1</sup><br>Width x Height<br>(mm x mm) | Size<br>Code |  |  |  |
|--|---|--------------|---|---|--|
|  |   |              | Chevron<br>Timber <sup>3</sup>  | Ashton <sup>3,4</sup>   | Ashton<br>Chevron <sup>3,4</sup>   |
| 1780 x 1806                                      | 1930 x 1891   | 6060         | 4853  | 5213  | 5446   |
| 1934 x 1806                                      | 2084 x 1891   | 6660         | 4853  | 5213  | 5446   |
| 1934 x 1907                                      | 2084 x 1991   | 6664         | 4853  | 5213  | 5446   |
| 1934 x 1957                                      | 2084 x 2041   | 6666         | 4867  | 5228  | 5456   |
| 1934 x 2112                                      | 2084 x 2196   | 6670         | 4924  | 5277  | 5516   |
| 2084 x 1806                                      | 2234 x 1891   | 7060         | 4924  | 5277  | 5516   |
| 2084 x 1907                                      | 2234 x 1991   | 7064         | 4958  | 5322  | 5557   |
| 2084 x 1957                                      | 2234 x 2041   | 7066         | 5016  | 5380  | 5611   |
| 2084 x 2112                                      | 2234 x 2196   | 7070         | 5045  | 5402  | 5641   |
| 2209 x 1907                                      | 2359 x 1991   | 7564         | 5197  | 5557  | 5790   |
| 2209 x 1957                                      | 2359 x 2041   | 7566         | 5228  | 5582  | 5822   |
| 2209 x 2112                                      | 2359 x 2196   | 7570         | 5322  | 5683  | 5918   |
| 2234 x 1907                                      | 2384 x 1991   | 7664         | 5213  | 5569  | 5807   |
| 2234 x 1957                                      | 2384 x 2041   | 7666         | 5277  | 5641  | 5874   |
| 2234 x 2112                                      | 2384 x 2196   | 7670         | 5380  | 5733  | 5975   |
| 2389 x 1907                                      | 2539 x 1991   | 8064         | 5683  | 6040  | 6278   |
| 2389 x 1957                                      | 2539 x 2041   | 8066         | 5711  | 5595  | 6308   |
| 2389 x 2112                                      | 2539 x 2196   | 8070         | 5862  | 6221  | 6455   |

<sup>1</sup> No fitting clearance allowed.

<sup>2</sup> The above doors are shown as 50/50 door leaves configuration. Up to 2234 mm overall frame width these doors are also available as a 1/3 2/3 door configuration on Vertical Timber and Horizontal Timber doors.

Prices are the same but please be aware panel configurations may be different from those shown above (1/3 2/3 is a term used to describe these doors but please note the 1/3 door leaf is always 800 mm wide with the 2/3 element varying to make the desired overall width). 1/3 leaf is always leading.

<sup>3</sup> Not available in 70/30 configuration. Only Vertical Timber and Horizontal Timber Side Hinged doors are available in 70/30 configuration up to 7'0" wide.

<sup>4</sup> On doors with windows, please state on order if plain or crystal panes.

### Timber door - purpose-made sizes

Overall frame size  
(between fix)<sup>1</sup>  
Width x Height  
(mm x mm)

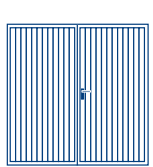
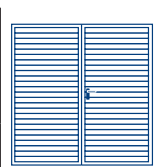
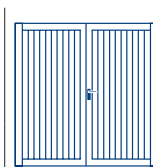
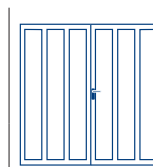
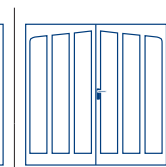
|                           | <br>Vertical<br>Timber <sup>2</sup> | <br>Horizontal<br>Timber <sup>2</sup> | <br>Kingsbury <sup>3</sup> | <br>Seymour <sup>3</sup> | <br>Tudor <sup>3</sup> |
|---------------------------|--|--|--|---|---|
| 1930 - 2234 x 1891 - 2041 | 4627   | 4717   | 5101   | 4423  | 4423  |
| 1930 - 2234 x 2042 - 2196 | 4717   | 4811   | 5196   | 4515  | 4515  |
| 2235 - 2384 x 1891 - 2041 | 4807   | 4903   | 5292   | 4610  | 4610  |
| 2235 - 2384 x 2042 - 2196 | 4936   | 5029   | 5657   | 4735  | 4735  |
| 2385 - 2539 x 1891 - 2041 | 5196   | 5292   | 5927   | 4994  | 4994  |
| 2385 - 2539 x 2042 - 2196 | 5275   | 5375   | 6023   | 5071  | 5071  |

<sup>1</sup> No fitting clearance allowed.

<sup>2</sup> On doors with windows, please state on order if plain or crystal panes.

### Timber door - purpose-made sizes

Overall frame size  
(between fix)<sup>1</sup>  
Width x Height  
(mm x mm)

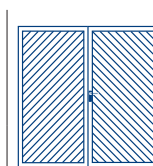
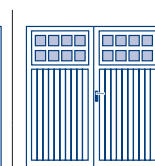
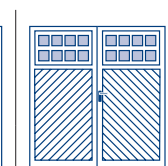
|                           | <br>Chevron<br>Timber <sup>3</sup> | <br>Ashton <sup>3,4</sup> | <br>Ashton<br>Chevron <sup>3,4</sup> |
|---------------------------|---|--|--|
| 1930 - 2234 x 1891 - 2041 | 5101  | 5452   | 5684   |
| 1930 - 2234 x 2042 - 2196 | 5196  | 5552   | 5779   |
| 2235 - 2384 x 1891 - 2041 | 5292  | 5643   | 5874   |
| 2235 - 2384 x 2042 - 2196 | 5657  | 6029   | 7358   |
| 2385 - 2539 x 1891 - 2041 | 5927  | 6300   | 6543   |
| 2385 - 2539 x 2042 - 2196 | 6023  | 6384   | 6630   |

<sup>1</sup> No fitting clearance allowed.



<sup>2</sup> The above doors are shown as 50/50 door leaves configuration. Up to 2234 mm overall frame width these doors are also available as a 1/3 2/3 door configuration on Vertical Timber and Horizontal Timber doors.

Prices are the same but please be aware panel configurations may be different from those shown above (1/3 2/3 is a term used to describe these doors but please note the 1/3 door leaf is always 800 mm wide with the 2/3 element varying to make the desired overall width). 1/3 leaf is always leading.

<sup>3</sup> Not available in 70/30 configuration. Only Vertical Timber and Horizontal Timber Side Hinged doors are available in 70/30 configuration up to 7'0" wide.

<sup>4</sup> On doors with windows, please state on order if plain or crystal panes.

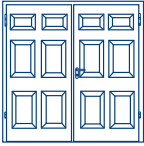
**GRP door - standard sizes**

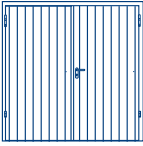
| Nominal Door Size<br>(between fix) <sup>1</sup><br>Width x Height<br>(mm x mm) | Overall frame size<br>(between fix) <sup>1</sup><br>Width x Height<br>(mm x mm) | Size Code |  |  |  |  |
|--|---|-----------|---|---|--|---|
|  |   |           | Dorchester <sup>2</sup>   | Kenmore   | Arden  | Somerset <sup>3</sup>   |
| 1780 x 1806  | 1930 x 1891   | 6060      | -   | -   | -  | 3782  |
| 1934 x 1806  | 2084 x 1891   | 6660      | -   | -   | -  | 3782  |
| 1934 x 1907  | 2084 x 1991   | 6664      | -   | -   | -  | 3782  |
| 1934 x 1957  | 2084 x 2041   | 6666      | -   | -   | -  | 3782  |
| 1934 x 2112  | 2084 x 2196   | 6670      | -   | -   | -  | 3782  |
| 2084 x 1806  | 2234 x 1891   | 7060      | -   | -   | -  | 3830  |
| 2084 x 1907  | 2234 x 1991   | 7064      | -   | -   | -  | 3830  |
| 2084 x 1957  | 2234 x 2041   | 7066      | -   | -   | -  | 3882  |
| 2084 x 2112  | 2234 x 2196   | 7070      | -   | -   | -  | 3882  |
| 2209 x 1907  | 2359 x 1991   | 7564      | 4004  | 4004  | 4004   | 4004  |
| 2209 x 1957  | 2359 x 2041   | 7566      | 4004  | 4004  | 4004   | 4004  |
| 2209 x 2112  | 2359 x 2196   | 7570      | 4004  | 4004  | 4004   | 4004  |
| 2234 x 1907  | 2384 x 1991   | 7664      | 4004  | 4004  | 4004   | 4004  |
| 2234 x 1957  | 2384 x 2041   | 7666      | 4004  | 4004  | 4004   | 4004  |
| 2234 x 2112  | 2384 x 2196   | 7670      | 4004  | 4004  | 4004   | 4004  |
| 2389 x 1907  | 2539 x 1991   | 8064      | 4128  | 4128  | 4128   | 4128  |
| 2389 x 1957  | 2539 x 2041   | 8066      | 4128  | 4128  | 4128   | 4128  |
| 2389 x 2112  | 2539 x 2196   | 8070      | 4128  | 4128  | 4128   | 4128  |

**GRP door - purpose-made sizes**

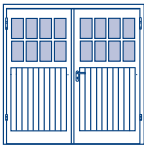
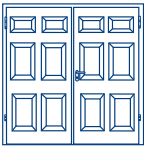
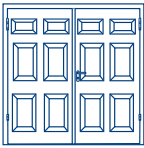
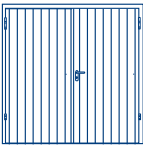
| Overall frame size<br>(between fix) <sup>1</sup><br>Width x Height<br>(mm x mm) |  |  |  |  |
|---|---|---|--|---|
|   | Dorchester <sup>2</sup>   | Kenmore   | Arden  | Somerset <sup>3</sup>   |
| 1930 - 2234 x 1891 - 2041   | -   | -   | -  | 4456  |
| 1930 - 2234 x 2042 - 2196   | -   | -   | -  | 4539  |
| 2235 - 2384 x 1891 - 2041   | -   | -   | -  | 4623  |
| 2235 - 2384 x 2042 - 2196   | -   | -   | -  | 4708  |
| 2385 - 2539 x 1891 - 2041 <sup>1</sup>  | 4791  | 4791  | 4791   | 4791  |
| 2385 - 2539 x 2042 - 2196   | 4869  | 4869  | 4869   | 4869  |

<sup>1</sup> Please note Dorchester, Kenmore and Arden side-hinged garage doors have a minimum overall frame size of 2359 mm x 1980 mm.

<sup>2</sup> For Dorchester side-hinged garage doors, only clear glazing or stippled glazing available for windows.

<sup>3</sup> The Somerset GRP side-hinged garage door is also available in a 70/30 configuration. All other GRP side-hinged garage doors are only available in 50/50 configuration.

| Options  | Steel                    |                          | Timber                   |                          | GRP                      |                          |
|--|--------------------------|--------------------------|--------------------------|--------------------------|--------------------------|--------------------------|
|  | Garage side doors<br>add | Side-hinged doors<br>add | Garage side doors<br>add | Side-hinged doors<br>add | Garage side doors<br>add | Side-hinged doors<br>add |
| For powder-coated steel doors <sup>1</sup> :<br>- Moss Green (RAL 6005)<br>- Ruby Red (RAL 3003)<br>- Signal Blue (RAL 5005)<br>- Jet Black (RAL 9005)<br>- Steel Blue (RAL 5011)<br>- Light Ivory (RAL 1015)<br>- Pigeon Blue (RAL 5014)<br>- Fir Green (RAL 6009)<br>- Anthracite Grey (RAL 7016)<br>- Stone Grey (RAL 7030)<br>- Light Grey (RAL 7035)<br>- Slate Grey (RAL 7015)<br>- Agate Grey (RAL 7038)<br>- Window Grey (RAL 7040)<br>- Chartwell Green (BS 4800)<br>- Burgundy Brown<br>- Golden Brown<br>- Terra Brown (RAL 8028) | 135                      | 176                      | -                        | -                        | -                        | -                        |
| Colour matched windows for Salisbury side-hinged doors <sup>2</sup>  | -                        | 221                      | -                        | -                        | -                        | -                        |
| Black window panes for Salisbury doors (price per door)  | -                        | 50                       | -                        | -                        | -                        | -                        |
| Coloured window frames to match door colour – Beaumont doors (price per window). Beaumont doors up to 2539 mm wide = 4 windows <sup>3</sup> .  | 65 each                  | 65 each                  | -                        | -                        | -                        | -                        |
| Surcharge for Premium GRP colours:<br>- Green<br>- Blue  | -                        | -                        | -                        | -                        | -                        | 811                      |
| Handles for steel and timber doors:<br>- knob/lever black plastic  | 45                       | 45                       | 45                       | 45                       | 45                       | 45                       |
| For timber doors: factory fully finished in<br>- Light Oak<br>- Antique Oak<br>- Mahogany<br>- Walnut<br>- Chestnut<br>- Ebony   | -                        | -                        | 188                      | 285                      | -                        | -                        |
| Factory white primer ready for on-site painting  | -                        | -                        | 285                      | 350                      | -                        | -                        |
| Factory fully finished painting (any RAL colour)   | -                        | -                        | 471                      | 585                      | -                        | -                        |
| Anodised Aluminium lever/lever handles:<br>- white   | 166                      | 166                      | 166                      | 166                      | -                        | 166                      |
| Anodised Aluminium lever/lever handles:<br>- chrome effect   | 207                      | 207                      | 207                      | 207                      | -                        | 207                      |
| Left hand leading  | 121                      | 121                      | 121                      | 121                      | -                        | 121                      |
| Fitting compensation kit (part no. 8261)   | 184                      | 184                      | 184                      | 184                      | 184                      | 184                      |
| Poly-wrapping  | 47                       | 47                       | -                        | -                        | -                        | -                        |

<sup>1</sup> Coloured Beaumont with windows doors are supplied with white window frames as standard.

<sup>2</sup> Only available on steel side-hinged doors.

<sup>3</sup> Colour match windows not available in Burgundy Brown or Golden Brown.

For timber side-hinged doors chassis is either Traffic White (RAL 9016) or Terra Brown (RAL 8028) regardless of exact colour of timber finishing, there is a charge of £176, except when Ebony finishing is ordered and then the chassis will be supplied in black.

# Garage Side Doors & Side-hinged Doors – Specifications

Door leaves supplied factory pre-framed ready for site installation. Fixed leaf (RH side when viewed from inside) fitted with tower bolts at top and bottom of inner leading edge. The floor will need to be finished and level for the bottom tower bolts to engage. These doors are designed for in-between fixing.

## Garage Side door factory pre-framed

### Between brickwork fixing

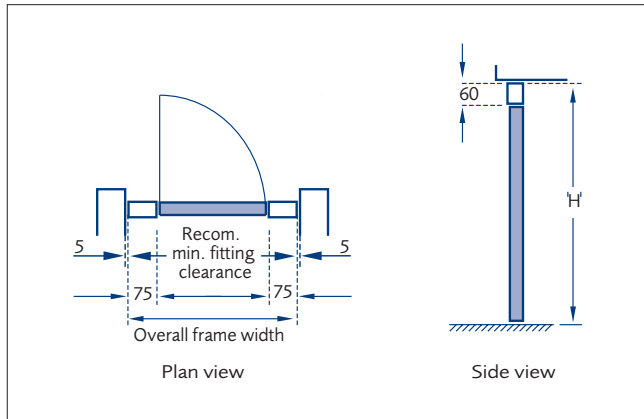

### Door specification

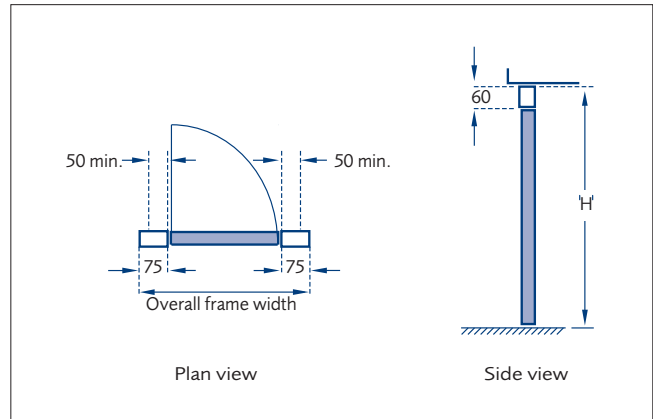

The nominal clear passage clearance is 74 mm less than the opening width and 125 mm less than the opening height. **Not recommended** for behind brickwork fixing.

## Side-hinged door factory pre-framed

### Between brickwork fixing

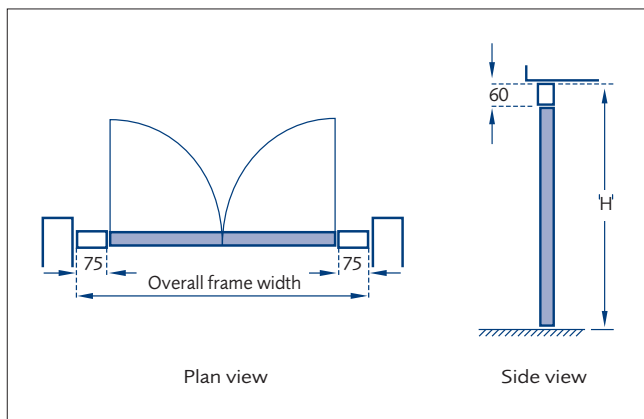

### Door specification

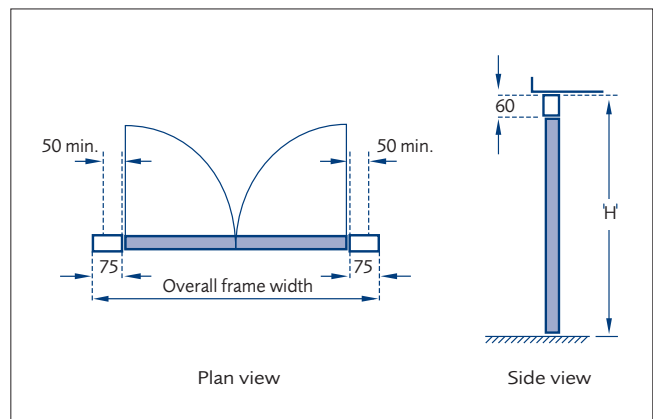

The nominal drive through clearance is 30 mm less than the opening width and 125 mm less than the opening height. **Not recommended** for behind brickwork fixing.

## Side-Hinged Garage Door Steel Frame Specifications

|                   | Width | Height | Depth |
|-------------------|-------|--------|-------|
| Side-Hinged Doors | 75 mm | 60 mm  | 75 mm |

# Steel Panel Doors – Specifications

## Canopy Gear Specifications

The canopy gear allows the door to travel in vertical tracks and is counterbalanced by an overhead torsion spring. The nominal drive through is 40 mm less than the opening width and 130 mm less than the opening height.

In the open position, the door projects approximately one third of the door height, forming a canopy.

For doors fitted with an operator, please observe operator specifications.

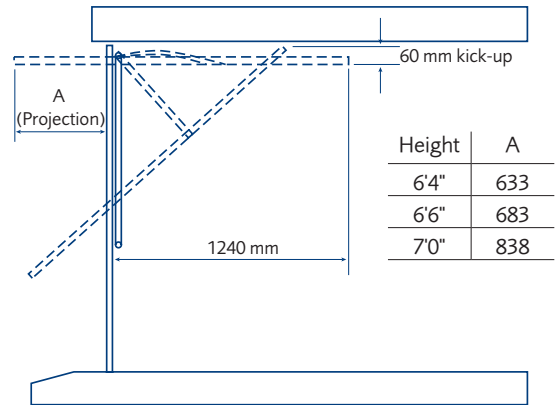

## On-site timber frame

### Behind brickwork fixing

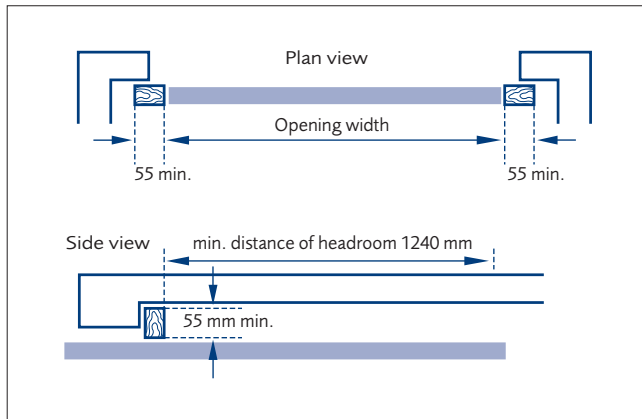

### Between brickwork fixing

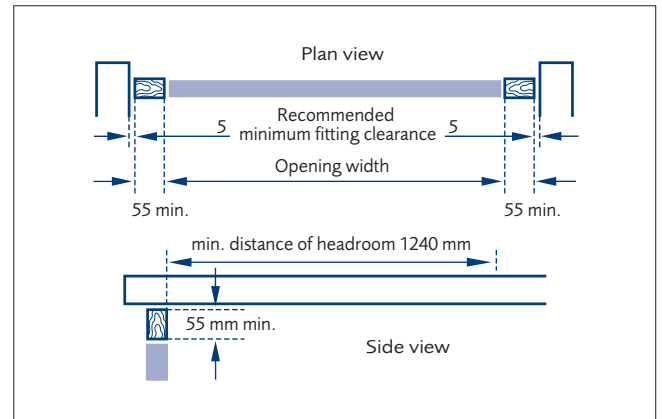

## Factory pre-framed with steel box frame

The garage door is supplied factory fitted to a steel box section frame and is secured to the brickwork by using just 7 fixings.

### Behind brickwork fixing

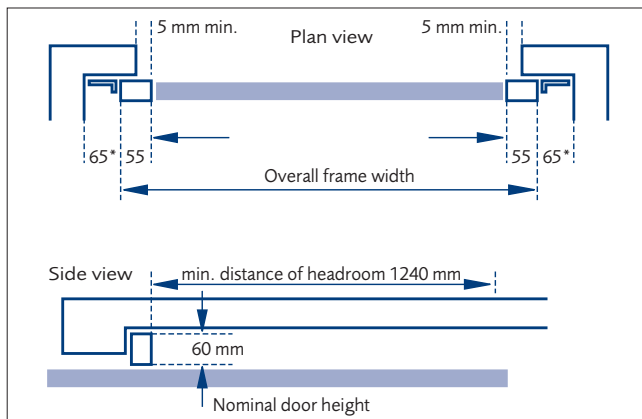

\* width of anchor brackets in this position

### Between brickwork fixing

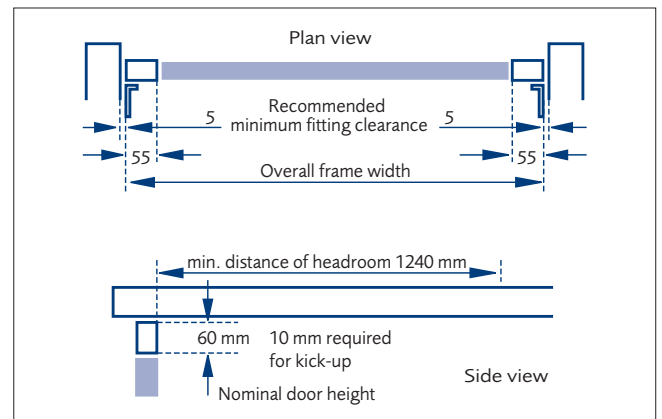

## Up & Over Garage Door Steel Frame Dimensions

|                                       | Width | Depth |
|---------------------------------------|-------|-------|
| Canopy steel frame (single door)      | 60 mm | 40 mm |
| Retractable steel frame (single door) | 75 mm | 40 mm |
| Retractable steel frame (double door) | 75 mm | 80 mm |

## Single & Double Retractable Gear Specifications

The retractable gear allows the door to be retracted inside the garage when open by means of horizontal overhead tracks supported by wall or ceiling mounted suspension brackets. This gear is available as an option for single doors and comes as standard with double garage doors.

The nominal drive through clearance is 105 mm less than the opening width and 110 mm less than the opening height for single doors and 140 mm less than the opening height for double doors.

For doors fitted with an operator, please observe operator specifications.

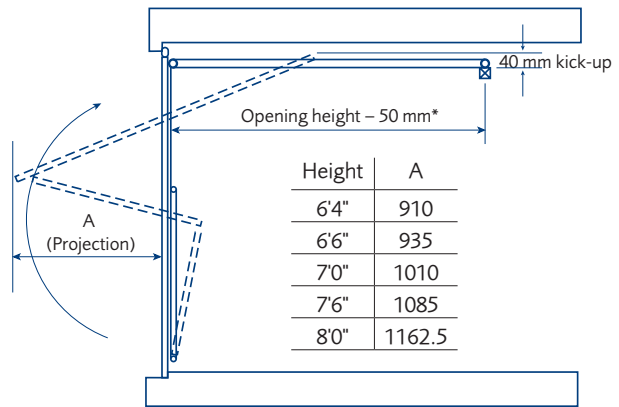

\* Only applies to single doors up to 1070.

### On-site timber frame

#### Behind brickwork fixing

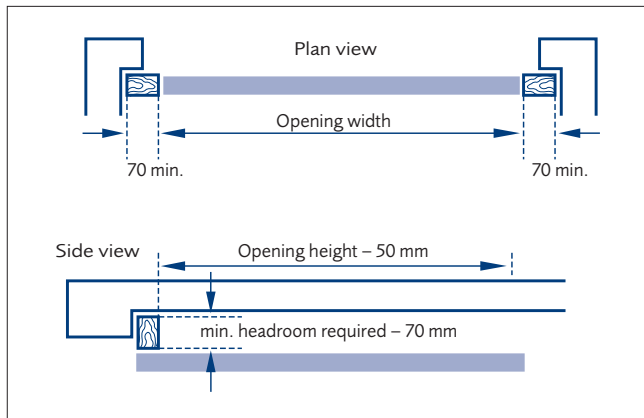

#### Between brickwork fixing

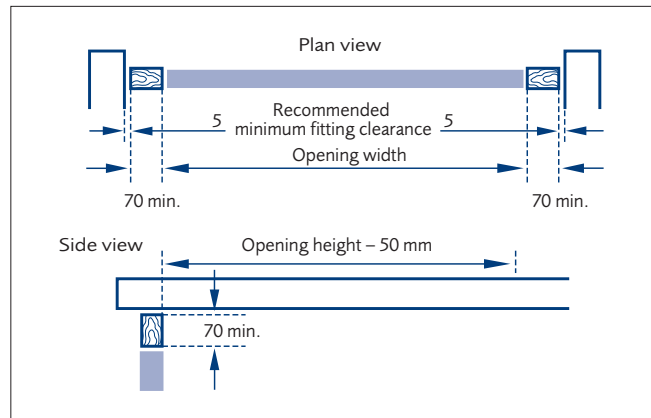

### Factory pre-framed with steel box frame

The garage door is supplied factory fitted to a steel box section frame and is secured to the brickwork by using just 7 fixings.

#### Behind brickwork fixing

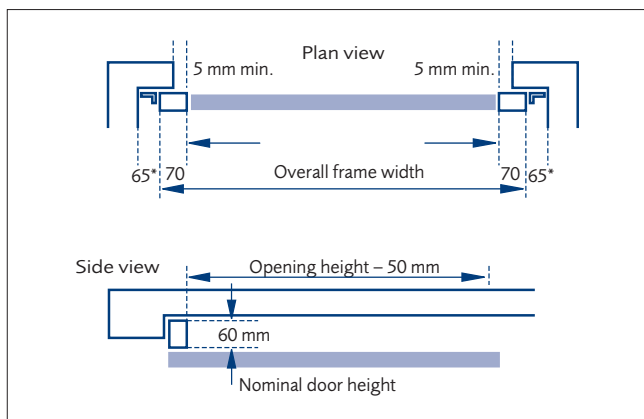

#### Between brickwork fixing

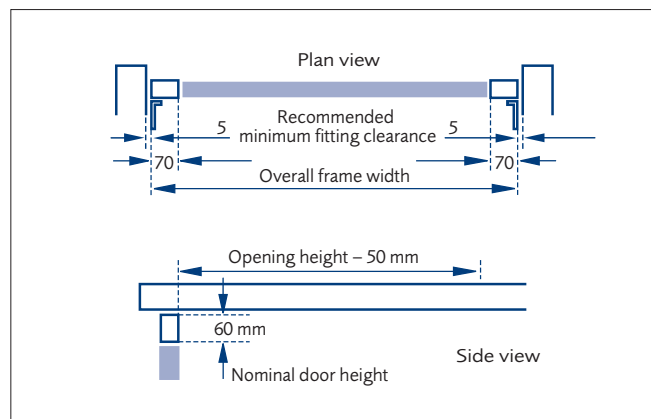

\* width of anchor brackets in this position

### Retractable Plus Gear

For any door up to a width of 2744 mm in any of the three standard heights Retractable Plus Gear is available. This gear type creates clear drive through width at the crucial wing mirror height.

| Door height | Clear height below lifting arms |
|-------------|---------------------------------|
| 7'0"        | 1260                            |
| 6'6"        | 1105                            |
| 6'4"        | 1055                            |

# Steel Sectional Garage Doors

## Door sections

Made of galvanised steel. Premium doors have a 42 mm thick insulated door section that is filled with PU-foam (100 % CFC-free). Bottom door section comes with floor seal.

## Surface

Outside: Woodgrain embossed, Slategrain, Sandgrain or Silkgrain textures with painted or foil coated finishes.

Inside: pebble texture.

## Spring arrangement

All doors up to 4000 mm wide (excluding Silkgrain) come with tension springs as standard and torsion springs are available at extra cost. All doors over 4000 mm wide (excluding Silkgrain) come with torsion springs as standard. Low headroom application available at extra cost. Doors with a Silkgrain surface finish are supplied with tension springs as standard up to 3049 mm wide and torsion springs as standard on doors over 3050 mm wide.

## Side frames & Fascia

Sectional doors are designed to be fitted behind the reveals and side frames are supplied white in colour. Cover profiles are available for use with coloured or foil coated door finishes. A single skin fascia is supplied with all doors which is finished in the same colour as the door sections. For Slategrain models, the door section has a Slategrain texture but the cover profiles and fascia are smooth.

## Colours

Steel Woodgrain and Silkgrain doors can be ordered in almost any colour from the RAL colour chart. Slategrain is only available in standard RAL colours and Traffic White (RAL 9016).

Standard colours are:

- |                          |                              |                              |                             |
|--------------------------|------------------------------|------------------------------|-----------------------------|
| - Light Ivory (RAL 1015) | - Anthracite Grey (RAL 7016) | - Quartz Grey (RAL 7039)     | - Grey Aluminium (RAL 9007) |
| - Moss Green (RAL 6005)  | - Titan Metallic (CH 703)    | - Window Grey (RAL 7040)     | - Chartwell Green (BS 4800) |
| - Fir Green (RAL 6009)   | - Stone Grey (RAL 7030)      | - Terra Brown (RAL 8028)     |                             |
| - Basalt Grey (RAL 7012) | - Light Grey (RAL 7035)      | - Jet Black (RAL 9005)       |                             |
| - Slate Grey (RAL 7015)  | - Agate Grey (RAL 7038)      | - White Aluminium (RAL 9006) |                             |

Special RAL colours are:

- |                         |                          |                             |                            |
|-------------------------|--------------------------|-----------------------------|----------------------------|
| - Black Red (RAL 3007)  | - Black Grey (RAL 7021)  | - Signal Black (RAL 9004)   | - Traffic Black (RAL 9017) |
| - Black Blue (RAL 5004) | - Black Brown (RAL 8022) | - Graphite Black (RAL 9011) |                            |

Non standard RAL colours are:

Based on full RAL colour chart excluding Traffic Purple (RAL 4006), Purple Violet (RAL 4007) and pearlescent or florescent options.

Timber effect foil coated doors are available in the following five finishes:

Golden Oak, Dark Oak, Night Oak, Rosewood and Winchester Oak. Only Golden Oak and Rosewood surface finishes are kept as stock door sizes (prices highlighted in bold) for timber effect sectional garage doors. Dark Oak, Night Oak and Winchester Oak surface finishes are not stocked, but are made to order.

Foil coated finish also available in Titan Metallic (CH 703)

## Handle

Sectional doors in shaded boxes are generally supplied ex-works for automatic operation, i.e. without handle hole and lock. Factory-fitted handle and lock are available with an increased lead-time. All other doors are on a 4 to 6 week lead-time. For electrical operation of a garage with no other personal access, an emergency release kit must be fitted.

## Packaging

Sectional doors are provided in a palletted format shrink wrapped for easy handling.

## Stock availability

Popular sectional doors are generally ex-stock in Traffic White (RAL 9016) and Terra Brown (RAL 8028) in some sizes, other sizes and colour options require up to 6 weeks lead-time. Contact sales office for further details.

## Gears

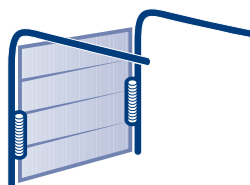

Tension spring

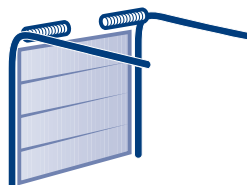

Torsion spring

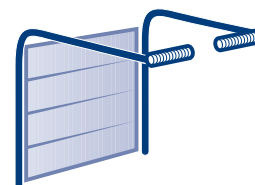

Low headroom torsion spring fitting



## Window options

### Georgian design

Prices £ stated per window  
Window frames white as standard

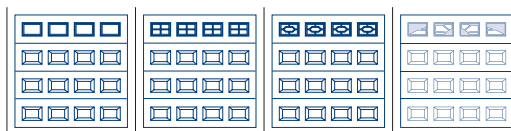

|                                      | Standard | Cross | Diamond | Sunrise |
|--------------------------------------|----------|-------|---------|---------|
| Premium - Woodgrain <sup>1</sup>     | 144      | 180   | 180     | 185     |
| Premium - Timber effect <sup>2</sup> | 185      | 219   | 219     | 227     |

### Linear small design

Prices £ stated per window  
Window frames white as standard

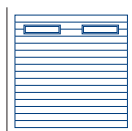

|                                  | Linear 1 |
|----------------------------------|----------|
| Premium - Woodgrain <sup>1</sup> | 144      |

### Linear medium design

Prices £ stated per window  
Window frames white as standard



|  | Standard | Cross | Diamond | Sunrise | Linear 1 | Linear 2 |
|--|----------|-------|---------|---------|----------|----------|
| Premium - Woodgrain Sandgrain, Silkgrain <sup>1</sup> , Slategrain | 144      | 180   | 180     | 185     | 144      | 177      |
| Premium - Timber effect <sup>2</sup>                               | 185      | 219   | 219     | 227     | 185      | 217      |

### Linear large design

Prices £ stated per window  
Window frames white as standard



|  | Standard | Cross | Diamond | Sunrise | Linear 1 | Linear 2 | Linear 3 |
|--|----------|-------|---------|---------|----------|----------|----------|
| Premium - Sandgrain, Silkgrain, Slategrain | 144      | 180   | 180     | 185     | 144      | 177      | 229      |
| Premium - Timber effect <sup>2</sup>       | 185      | 219   | 219     | 227     | 185      | 217      | 269      |

<sup>1</sup> Colours available at surcharge per window (£ 44 for standard colour, £ 72 for non standard colour, £ 137 for special RAL colour).

<sup>2</sup> Window frames are painted in a colour to best complement the colour of the foil coat (colour incl. in price).

Please note, window frames are painted in a colour to complement the colour of the sectional garage door.

### Standard, Cross, Diamond and Sunrise (overall frame dimension: 395 mm x 270 mm)

Doors up to 2124 mm wide have 3 windows, 2125 mm to 2749 mm wide have 4 windows, 2750 mm to 3499 mm wide have 5 windows, 3500 mm to 3999 mm wide have 6 windows, 4000 mm to 4749 mm wide have 7 windows and doors of 4750 mm up to 5500 mm wide have 8 windows. Sunrise windows only available from 2130 mm wide doors up to 5500 mm wide doors.

### Linear 1 (overall frame dimension: 680 mm x 210 mm)

Doors up to 2499 mm wide have 2 windows, 2500 mm to 3499 mm wide have 3 windows, 3500 mm to 4499 mm wide have 4 windows and doors over 4500 mm wide have 5 windows.

### Linear 2 (overall frame dimension: 620 mm x 270 mm)

Doors up to 2239 mm wide have 2 windows, 2240 mm to 2969 mm wide have 3 windows, 2970 mm to 3689 mm wide have 4 windows, 3690 mm to 4419 mm wide have 5 windows and doors over 4420 mm have 6 windows.

### Linear 3 (overall frame dimension: 1004 mm x 270 mm)

Door widths from 2250 mm to 3399 mm have 2 windows, 3400 mm to 4489 mm have 3 windows, 4490 mm to 5499 mm have 4 windows, 5500 mm to 6000 mm have 6 windows.

Please state on order if clear or crystal panes. Georgian sectional doors under 7 ft wide only have 3 pressings.

### Secured by Design – Free optional upgrade available after installation

The following criteria must be met to be eligible for Secured by Design accreditation:

- Premium 42 mm sectional door (without windows).
- Fitted behind the opening.
- Automated with a GaraMatic operator (sold separately).
- Door must be fitted to SBD standard, unmodified and registered with Garador.



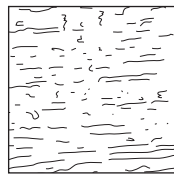
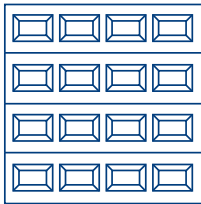

Woodgrain

## Georgian design

| Brickwork opening<br>Width x Height<br>(mm x mm) | Size<br>Code | <br>Premium | Surcharge<br>for<br>Standard<br>Colours | Surcharge<br>for<br>Non-Std.<br>Colours | Surcharge<br>for Special<br>RAL |
|--|--------------|--|---|---|---------------------------------|
|  |              |  |   |   |                                 |
| 2080 x 2000                                      | I 61066      | <b>1763</b>  | 238                                     | 390                                     | 759                             |
| 2080 x 2080                                      | I 610610     | <b>1783</b>  | 248                                     | 405                                     | 789                             |
| 2134 x 2000                                      | I 7066       | <b>1823</b>  | 245                                     | 399                                     | 778                             |
| 2134 x 2125                                      | I 7070       | <b>1846</b>  | 260                                     | 424                                     | 827                             |
| 2250 x 1900                                      | M 7462       | 1874   | 242                                     | 395                                     | 768                             |
| 2250 x 2000                                      | M 7466       | 1928   | 258                                     | 421                                     | 820                             |
| 2250 x 2125                                      | M 7470       | 1931   | 274                                     | 447                                     | 872                             |
| 2286 x 2000                                      | I 7666       | <b>1823</b>  | 262                                     | 428                                     | 834                             |
| 2286 x 2125                                      | I 7670       | <b>1846</b>  | 279                                     | 454                                     | 885                             |
| 2286 x 2250                                      | I 7674       | <b>1841</b>  | 294                                     | 481                                     | 938                             |
| 2286 x 2375                                      | I 7679       | 1967   | 310                                     | 507                                     | 990                             |
| 2286 x 2500                                      | I 7682       | 1963   | 327                                     | 535                                     | 1042                            |
| 2375 x 1900                                      | M 7962       | 1874   | 255                                     | 417                                     | 812                             |
| 2375 x 2000                                      | M 7966       | 1876   | 272                                     | 445                                     | 867                             |
| 2375 x 2125                                      | M 7970       | 1881   | 288                                     | 471                                     | 921                             |
| 2375 x 2250                                      | M 7974       | 1962   | 306                                     | 499                                     | 974                             |
| 2438 x 2000                                      | I 8066       | <b>1924</b>  | 280                                     | 455                                     | 889                             |
| 2438 x 2125                                      | I 8070       | <b>1954</b>  | 297                                     | 484                                     | 944                             |
| 2438 x 2250                                      | I 8074       | 1941   | 314                                     | 512                                     | 1000                            |
| 2438 x 2375                                      | I 8079       | 2069   | 332                                     | 541                                     | 1055                            |
| 2438 x 2500                                      | I 8082       | 2064   | 349                                     | 570                                     | 1111                            |
| 2500 x 1900                                      | M 8262       | 1874   | 269                                     | 437                                     | 854                             |
| 2500 x 2000                                      | M 8266       | 1876   | 286                                     | 467                                     | 911                             |
| 2500 x 2125                                      | M 8270       | 1881   | 304                                     | 497                                     | 968                             |
| 2500 x 2250                                      | M 8274       | 1962   | 322                                     | 525                                     | 1026                            |
| 2500 x 2375                                      | M 8279       | 2057   | 340                                     | 555                                     | 1083                            |
| 2500 x 2500                                      | M 8282       | 2062   | 358                                     | 583                                     | 1140                            |
| 2500 x 2750                                      | M 8290       | 2233   | 394                                     | 642                                     | 1253                            |
| 2591 x 2000                                      | I 8666       | 1924   | 297                                     | 484                                     | 944                             |
| 2591 x 2125                                      | I 8670       | <b>1954</b>  | 315                                     | 515                                     | 1003                            |
| 2625 x 2125                                      | M 8770       | 2036   | 319                                     | 521                                     | 1017                            |
| 2740 x 2000                                      | I 9066       | <b>2095</b>  | 314                                     | 512                                     | 999                             |
| 2740 x 2125                                      | I 9070       | <b>2124</b>  | 334                                     | 544                                     | 1062                            |
| 2750 x 2000                                      | M 9166       | 2272   | 315                                     | 515                                     | 1002                            |
| 2750 x 2125                                      | M 9170       | 2315   | 335                                     | 546                                     | 1066                            |
| 2750 x 2250                                      | M 9174       | 2401   | 354                                     | 578                                     | 1128                            |
| 2750 x 2375                                      | M 9179       | 2420   | 374                                     | 610                                     | 1191                            |
| 2750 x 2500                                      | M 9182       | 2501   | 394                                     | 642                                     | 1253                            |
| 2896 x 2000                                      | I 9666       | 2199   | 332                                     | 541                                     | 1055                            |
| 2896 x 2125                                      | I 9670       | 2241   | 352                                     | 575                                     | 1122                            |
| 3000 x 2000                                      | M 91066      | 2387   | 343                                     | 560                                     | 1093                            |
| 3000 x 2125                                      | M 91070      | 2385   | 365                                     | 596                                     | 1162                            |
| 3000 x 2250                                      | M 91074      | 2460   | 387                                     | 631                                     | 1231                            |
| 3000 x 2375                                      | M 91079      | 2504   | 408                                     | 666                                     | 1298                            |
| 3000 x 2500                                      | M 91082      | 2586   | 429                                     | 701                                     | 1367                            |
| 3000 x 3000                                      | M 910910     | 3362   | 515                                     | 840                                     | 1640                            |
| 3048 x 2000                                      | I 1066       | <b>2110</b>  | 349                                     | 570                                     | 1111                            |
| 3048 x 2125                                      | I 1070       | <b>2154</b>  | 371                                     | 606                                     | 1180                            |
| 3250 x 2000                                      | M 10866      | 2478   | 372                                     | 608                                     | 1185                            |
| 3250 x 2125                                      | M 10870      | 2545   | 395                                     | 645                                     | 1258                            |
| 3250 x 2250                                      | M 10874      | 2626   | 418                                     | 684                                     | 1333                            |
| 3353 x 2000                                      | I 1166       | 2522   | 383                                     | 627                                     | 1222                            |
| 3353 x 2125                                      | I 1170       | <b>2566</b>  | 408                                     | 666                                     | 1298                            |
| 3500 x 2000                                      | M 11666      | 2699   | 400                                     | 654                                     | 1276                            |

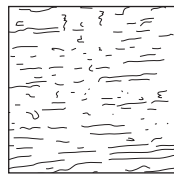
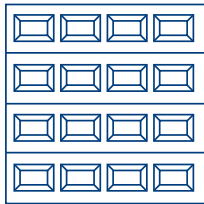

Woodgrain

Georgian design

Brickwork opening  
Width x Height  
(mm x mm)

Size Code



Premium

Surcharge for Standard Colours

Surcharge for Non-Std. Colours

Surcharge for Special RAL

| Brickwork opening<br>Width x Height<br>(mm x mm) | Size Code |        | Surcharge for Standard Colours | Surcharge for Non-Std. Colours | Surcharge for Special RAL |      |
|--|-----------|--------|--------------------------------|--------------------------------|---------------------------|------|
| 3500 x 2125                                      | <b>M</b>  | 11670  | 2769                           | 426                            | 694                       | 1356 |
| 3500 x 2250                                      | <b>M</b>  | 11674  | 2857                           | 451                            | 735                       | 1435 |
| 3658 x 2000                                      | <b>I</b>  | 1266   | 2975                           | 418                            | 684                       | 1333 |
| 3658 x 2125                                      | <b>I</b>  | 1270   | <b>3023</b>                    | 445                            | 726                       | 1416 |
| 3750 x 2000                                      | <b>M</b>  | 12466  | 2914                           | 429                            | 701                       | 1367 |
| 3750 x 2125                                      | <b>M</b>  | 12470  | 2990                           | 455                            | 744                       | 1453 |
| 3750 x 2250                                      | <b>M</b>  | 12474  | 3084                           | 483                            | 788                       | 1539 |
| 3962 x 2000                                      | <b>I</b>  | 1366   | <b>3094</b>                    | 453                            | 741                       | 1443 |
| 3962 x 2125                                      | <b>I</b>  | 1370   | <b>3137</b>                    | 482                            | 786                       | 1534 |
| 4000 x 2000                                      | <b>M</b>  | 13266  | 3120                           | 457                            | 747                       | 1458 |
| 4000 x 2125                                      | <b>M</b>  | 13270  | 3199                           | 486                            | 794                       | 1549 |
| 4000 x 2250                                      | <b>M</b>  | 13274  | 3301                           | 515                            | 840                       | 1640 |
| 4250 x 2000                                      | <b>M</b>  | 131166 | 3218                           | 486                            | 794                       | 1549 |
| 4250 x 2125                                      | <b>M</b>  | 131170 | 3306                           | 517                            | 844                       | 1645 |
| 4250 x 2250                                      | <b>M</b>  | 131174 | 3407                           | 546                            | 893                       | 1742 |
| 4267 x 2000                                      | <b>I</b>  | 1466   | <b>3217</b>                    | 488                            | 796                       | 1556 |
| 4267 x 2125                                      | <b>I</b>  | 1470   | <b>3268</b>                    | 519                            | 847                       | 1652 |
| 4420 x 2000                                      | <b>I</b>  | 14666  | 3333                           | 506                            | 825                       | 1611 |
| 4420 x 2125                                      | <b>I</b>  | 14670  | <b>3389</b>                    | 537                            | 876                       | 1711 |
| 4500 x 2000                                      | <b>M</b>  | 14966  | 3306                           | 515                            | 840                       | 1640 |
| 4500 x 2125                                      | <b>M</b>  | 14970  | 3406                           | 546                            | 893                       | 1742 |
| 4500 x 2250                                      | <b>M</b>  | 14974  | 3514                           | 579                            | 945                       | 1845 |
| 4572 x 2000                                      | <b>I</b>  | 1566   | <b>3395</b>                    | 522                            | 853                       | 1667 |
| 4572 x 2125                                      | <b>I</b>  | 1570   | <b>3450</b>                    | 555                            | 907                       | 1770 |
| 4725 x 2000                                      | <b>I</b>  | 15666  | <b>3562</b>                    | 540                            | 882                       | 1723 |
| 4725 x 2125                                      | <b>I</b>  | 15670  | <b>3617</b>                    | 574                            | 937                       | 1830 |
| 4750 x 2000                                      | <b>M</b>  | 15766  | 3407                           | 543                            | 887                       | 1731 |
| 4750 x 2125                                      | <b>M</b>  | 15770  | 3507                           | 577                            | 942                       | 1840 |
| 4750 x 2250                                      | <b>M</b>  | 15774  | 3613                           | 611                            | 997                       | 1947 |
| 4877 x 2000                                      | <b>I</b>  | 1666   | <b>3562</b>                    | 557                            | 910                       | 1778 |
| 4877 x 2125                                      | <b>I</b>  | 1670   | <b>3617</b>                    | 593                            | 967                       | 1888 |
| 5000 x 2000                                      | <b>M</b>  | 16566  | 3502                           | 572                            | 933                       | 1822 |
| 5000 x 2125                                      | <b>M</b>  | 16570  | 3583                           | 608                            | 992                       | 1936 |
| 5000 x 2250                                      | <b>M</b>  | 16574  | 3696                           | 643                            | 1050                      | 2051 |
| 5000 x 2375                                      | <b>M</b>  | 16579  | 3832                           | 679                            | 1108                      | 2164 |
| 5000 x 2500                                      | <b>M</b>  | 16582  | 3821                           | 714                            | 1167                      | 2277 |
| 5500 x 2000                                      | <b>M</b>  | 18166  | 3788                           | 629                            | 1027                      | 2004 |
| 5500 x 2125                                      | <b>M</b>  | 18170  | 3952                           | 668                            | 1090                      | 2129 |
| 5500 x 2250                                      | <b>M</b>  | 18174  | 4180                           | 707                            | 1156                      | 2255 |

Prices in bold are generally a stock item. Non-bold prices require a longer lead-time.

Purpose-made sizes available upon request. Non standard colours also available upon request. Doors supplied without locking as standard (see options on page 67 for handles). For window options please see page 49.

**I** Imperial door sizes.

**M** Metric door sizes. Extended lead time of 4-6 weeks.

Supplied as standard with tension spring gear. Torsion spring fitting available for Premium doors at £ 107 surcharge.

Supplied as standard with torsion spring gear. Low headroom fitting available at £ 176 surcharge.

Purpose-made sizes available upon request. Non standard colours also available upon request. Doors supplied without locking as standard (see options on page 67 for handles). For window options please see page 49.

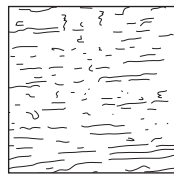
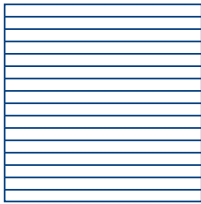

Woodgrain

## Linear small design

| Brickwork opening<br>Width x Height<br>(mm x mm) | Size<br>Code | <br>Premium | Surcharge<br>for<br>Standard<br>Colours | Surcharge<br>for<br>Non-Std.<br>Colours | Surcharge<br>for Special<br>RAL |
|--|--------------|--|---|---|---------------------------------|
|  |              |  |   |   |                                 |
| 2080 x 2000                                      | I 61066      | 1393   | 238                                     | 390                                     | 759                             |
| 2080 x 2080                                      | I 610610     | 1444   | 248                                     | 405                                     | 789                             |
| 2134 x 2000                                      | I 7066       | <b>1443</b>  | 245                                     | 399                                     | 778                             |
| 2134 x 2125                                      | I 7070       | <b>1492</b>  | 260                                     | 424                                     | 827                             |
| 2250 x 1900                                      | M 7462       | 1525   | 242                                     | 395                                     | 768                             |
| 2250 x 2000                                      | M 7466       | 1572   | 258                                     | 421                                     | 820                             |
| 2250 x 2125                                      | M 7470       | 1575   | 274                                     | 447                                     | 872                             |
| 2286 x 2000                                      | I 7666       | <b>1443</b>  | 262                                     | 428                                     | 834                             |
| 2286 x 2125                                      | I 7670       | <b>1492</b>  | 279                                     | 454                                     | 885                             |
| 2286 x 2250                                      | I 7674       | 1513   | 294                                     | 481                                     | 938                             |
| 2286 x 2375                                      | I 7679       | 1631   | 310                                     | 507                                     | 990                             |
| 2286 x 2500                                      | I 7682       | 1628   | 327                                     | 535                                     | 1042                            |
| 2375 x 1900                                      | M 7962       | 1525   | 255                                     | 417                                     | 812                             |
| 2375 x 2000                                      | M 7966       | 1527   | 272                                     | 445                                     | 867                             |
| 2375 x 2125                                      | M 7970       | 1527   | 288                                     | 471                                     | 921                             |
| 2375 x 2250                                      | M 7974       | 1557   | 306                                     | 499                                     | 974                             |
| 2438 x 2000                                      | I 8066       | 1516   | 280                                     | 455                                     | 889                             |
| 2438 x 2125                                      | I 8070       | <b>1577</b>  | 297                                     | 484                                     | 944                             |
| 2438 x 2250                                      | I 8074       | 1586   | 314                                     | 512                                     | 1000                            |
| 2438 x 2375                                      | I 8079       | 1709   | 332                                     | 541                                     | 1055                            |
| 2438 x 2500                                      | I 8082       | 1701   | 349                                     | 570                                     | 1111                            |
| 2500 x 1900                                      | M 8262       | 1525   | 269                                     | 437                                     | 854                             |
| 2500 x 2000                                      | M 8266       | 1527   | 286                                     | 467                                     | 911                             |
| 2500 x 2125                                      | M 8270       | 1527   | 304                                     | 497                                     | 968                             |
| 2500 x 2250                                      | M 8274       | 1557   | 322                                     | 525                                     | 1026                            |
| 2500 x 2375                                      | M 8279       | 1642   | 340                                     | 555                                     | 1083                            |
| 2500 x 2500                                      | M 8282       | 1645   | 358                                     | 583                                     | 1140                            |
| 2500 x 2750                                      | M 8290       | 2000   | 394                                     | 642                                     | 1253                            |
| 2591 x 2000                                      | I 8666       | 1516   | 297                                     | 484                                     | 944                             |
| 2591 x 2125                                      | I 8670       | 1577   | 315                                     | 515                                     | 1003                            |
| 2625 x 2125                                      | M 8770       | 1728   | 319                                     | 521                                     | 1017                            |
| 2740 x 2000                                      | I 9066       | 1643   | 314                                     | 512                                     | 999                             |
| 2740 x 2125                                      | I 9070       | 1699   | 334                                     | 544                                     | 1062                            |
| 2750 x 2000                                      | M 9166       | 1753   | 315                                     | 515                                     | 1002                            |
| 2750 x 2125                                      | M 9170       | 1809   | 335                                     | 546                                     | 1066                            |
| 2750 x 2250                                      | M 9174       | 1819   | 354                                     | 578                                     | 1128                            |
| 2750 x 2375                                      | M 9179       | 1868   | 374                                     | 610                                     | 1191                            |
| 2750 x 2500                                      | M 9182       | 1950   | 394                                     | 642                                     | 1253                            |
| 2896 x 2000                                      | I 9666       | 1717   | 332                                     | 541                                     | 1055                            |
| 2896 x 2125                                      | I 9670       | 1787   | 352                                     | 575                                     | 1122                            |
| 3000 x 2000                                      | M 91066      | 1967   | 343                                     | 560                                     | 1093                            |
| 3000 x 2125                                      | M 91070      | 1966   | 365                                     | 596                                     | 1162                            |
| 3000 x 2250                                      | M 91074      | 1983   | 387                                     | 631                                     | 1231                            |
| 3000 x 2375                                      | M 91079      | 2035   | 408                                     | 666                                     | 1298                            |
| 3000 x 2500                                      | M 91082      | 2119   | 429                                     | 701                                     | 1367                            |
| 3000 x 3000                                      | M 910910     | 2570   | 515                                     | 840                                     | 1640                            |
| 3048 x 2000                                      | I 1066       | 1659   | 349                                     | 570                                     | 1111                            |
| 3048 x 2125                                      | I 1070       | 1719   | 371                                     | 606                                     | 1180                            |
| 3250 x 2000                                      | M 10866      | 1978   | 372                                     | 608                                     | 1185                            |
| 3250 x 2125                                      | M 10870      | 2035   | 395                                     | 645                                     | 1258                            |
| 3250 x 2250                                      | M 10874      | 2080   | 418                                     | 684                                     | 1333                            |
| 3353 x 2000                                      | I 1166       | 1956   | 383                                     | 627                                     | 1222                            |
| 3353 x 2125                                      | I 1170       | 2035   | 408                                     | 666                                     | 1298                            |
| 3500 x 2000                                      | M 11666      | 2113   | 400                                     | 654                                     | 1276                            |

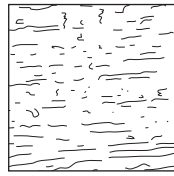
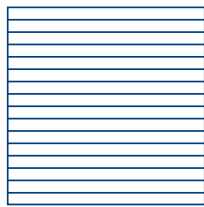

Woodgrain

Linear small design



Premium

| Brickwork opening<br>Width x Height<br>(mm x mm) | Size Code |        | Surcharge for Standard Colours | Surcharge for Non-Std. Colours | Surcharge for Special RAL |      |
|--|-----------|--------|--------------------------------|--------------------------------|---------------------------|------|
| 3500 x 2125                                      | <b>M</b>  | 11670  | 2166                           | 426                            | 694                       | 1356 |
| 3500 x 2250                                      | <b>M</b>  | 11674  | 2212                           | 451                            | 735                       | 1435 |
| 3658 x 2000                                      | <b>I</b>  | 1266   | 2300                           | 418                            | 684                       | 1333 |
| 3658 x 2125                                      | <b>I</b>  | 1270   | 2390                           | 445                            | 726                       | 1416 |
| 3750 x 2000                                      | <b>M</b>  | 12466  | 2229                           | 429                            | 701                       | 1367 |
| 3750 x 2125                                      | <b>M</b>  | 12470  | 2295                           | 455                            | 744                       | 1453 |
| 3750 x 2250                                      | <b>M</b>  | 12474  | 2340                           | 483                            | 788                       | 1539 |
| 3962 x 2000                                      | <b>I</b>  | 1366   | 2386                           | 453                            | 741                       | 1443 |
| 3962 x 2125                                      | <b>I</b>  | 1370   | 2476                           | 482                            | 786                       | 1534 |
| 4000 x 2000                                      | <b>M</b>  | 13266  | 2349                           | 457                            | 747                       | 1458 |
| 4000 x 2125                                      | <b>M</b>  | 13270  | 2420                           | 486                            | 794                       | 1549 |
| 4000 x 2250                                      | <b>M</b>  | 13274  | 2471                           | 515                            | 840                       | 1640 |
| 4250 x 2000                                      | <b>M</b>  | 131166 | 2481                           | 486                            | 794                       | 1549 |
| 4250 x 2125                                      | <b>M</b>  | 131170 | 2554                           | 517                            | 844                       | 1645 |
| 4250 x 2250                                      | <b>M</b>  | 131174 | 2610                           | 546                            | 893                       | 1742 |
| 4267 x 2000                                      | <b>I</b>  | 1466   | 2475                           | 488                            | 796                       | 1556 |
| 4267 x 2125                                      | <b>I</b>  | 1470   | <b>2574</b>                    | 519                            | 847                       | 1652 |
| 4420 x 2000                                      | <b>I</b>  | 14666  | 2558                           | 506                            | 825                       | 1611 |
| 4420 x 2125                                      | <b>I</b>  | 14670  | 2661                           | 537                            | 876                       | 1711 |
| 4500 x 2000                                      | <b>M</b>  | 14966  | 2608                           | 515                            | 840                       | 1640 |
| 4500 x 2125                                      | <b>M</b>  | 14970  | 2684                           | 546                            | 893                       | 1742 |
| 4500 x 2250                                      | <b>M</b>  | 14974  | 2737                           | 579                            | 945                       | 1845 |
| 4572 x 2000                                      | <b>I</b>  | 1566   | 2606                           | 522                            | 853                       | 1667 |
| 4572 x 2125                                      | <b>I</b>  | 1570   | 2708                           | 555                            | 907                       | 1770 |
| 4725 x 2000                                      | <b>I</b>  | 15666  | 2716                           | 540                            | 882                       | 1723 |
| 4725 x 2125                                      | <b>I</b>  | 15670  | 2823                           | 574                            | 937                       | 1830 |
| 4750 x 2000                                      | <b>M</b>  | 15766  | 2687                           | 543                            | 887                       | 1731 |
| 4750 x 2125                                      | <b>M</b>  | 15770  | 2765                           | 577                            | 942                       | 1840 |
| 4750 x 2250                                      | <b>M</b>  | 15774  | 2820                           | 611                            | 997                       | 1947 |
| 4877 x 2000                                      | <b>I</b>  | 1666   | 2716                           | 557                            | 910                       | 1778 |
| 4877 x 2125                                      | <b>I</b>  | 1670   | 2823                           | 593                            | 967                       | 1888 |
| 5000 x 2000                                      | <b>M</b>  | 16566  | 2766                           | 572                            | 933                       | 1822 |
| 5000 x 2125                                      | <b>M</b>  | 16570  | 2823                           | 608                            | 992                       | 1936 |
| 5000 x 2250                                      | <b>M</b>  | 16574  | 2879                           | 643                            | 1050                      | 2051 |
| 5000 x 2375                                      | <b>M</b>  | 16579  | 2939                           | 679                            | 1108                      | 2164 |
| 5000 x 2500                                      | <b>M</b>  | 16582  | 2998                           | 714                            | 1167                      | 2277 |
| 5500 x 2000                                      | <b>M</b>  | 18166  | 2959                           | 629                            | 1027                      | 2004 |
| 5500 x 2125                                      | <b>M</b>  | 18170  | 3040                           | 668                            | 1090                      | 2129 |
| 5500 x 2250                                      | <b>M</b>  | 18174  | 3117                           | 707                            | 1156                      | 2255 |

Prices in bold are generally a stock item. Non-bold prices require a longer lead-time.

- I** Imperial door sizes.
- M** Metric door sizes. Extended lead time of 4-6 weeks.
- Supplied as standard with tension spring gear. Torsion spring fitting available for Premium doors at £ 107 surcharge.
- Supplied as standard with torsion spring gear. Low headroom fitting available at £ 176 surcharge.

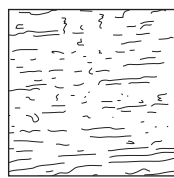

Woodgrain

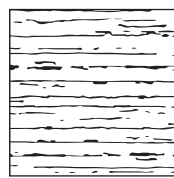
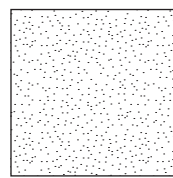
 Slategrain<sup>1</sup>

 Silkgrain<sup>2</sup>

## Linear medium design

 Brickwork  
opening  
Width x Height  
(mm x mm)

 Size  
Code

Premium



Premium



Premium

 Surcharge  
for  
Standard  
Colours

 Surcharge  
for  
Non-Std.  
Colours

 Surcharge  
for Special  
RAL

| Brickwork opening<br>Width x Height<br>(mm x mm) | Size Code       | Premium     | Premium | Premium     | Surcharge for Standard Colours | Surcharge for Non-Std. Colours | Surcharge for Special RAL |
|--|-----------------|-------------|---------|-------------|--------------------------------|--------------------------------|---------------------------|
| 2080 x 2000                                      | <b>I</b> 61066  | <b>1393</b> | 1393    | 1712        | 238                            | 390                            | 759                       |
| 2080 x 2080                                      | <b>I</b> 610610 | <b>1444</b> | 1444    | <b>1780</b> | 248                            | 405                            | 789                       |
| 2134 x 2000                                      | <b>I</b> 7066   | <b>1443</b> | 1443    | <b>1712</b> | 245                            | 399                            | 778                       |
| 2134 x 2125                                      | <b>I</b> 7070   | <b>1492</b> | 1492    | <b>1780</b> | 260                            | 424                            | 827                       |
| 2250 x 1900                                      | <b>M</b> 7462   | 1492        | 1525    | 1826        | 242                            | 395                            | 768                       |
| 2250 x 2000                                      | <b>M</b> 7466   | 1572        | 1572    | 1861        | 258                            | 421                            | 820                       |
| 2250 x 2125                                      | <b>M</b> 7470   | 1575        | 1575    | 1865        | 274                            | 447                            | 872                       |
| 2286 x 2000                                      | <b>I</b> 7666   | <b>1443</b> | 1443    | <b>1712</b> | 262                            | 428                            | 834                       |
| 2286 x 2125                                      | <b>I</b> 7670   | <b>1492</b> | 1492    | <b>1780</b> | 279                            | 454                            | 885                       |
| 2286 x 2250                                      | <b>I</b> 7674   | <b>1513</b> | 1513    | <b>1862</b> | 294                            | 481                            | 938                       |
| 2286 x 2375                                      | <b>I</b> 7679   | <b>1631</b> | 1631    | 1944        | 310                            | 507                            | 990                       |
| 2286 x 2500                                      | <b>I</b> 7682   | 1628        | 1628    | 2021        | 327                            | 535                            | 1042                      |
| 2375 x 1900                                      | <b>M</b> 7962   | 1525        | 1525    | 1826        | 255                            | 417                            | 812                       |
| 2375 x 2000                                      | <b>M</b> 7966   | 1527        | 1527    | 1831        | 272                            | 445                            | 867                       |
| 2375 x 2125                                      | <b>M</b> 7970   | 1527        | 1527    | 1836        | 288                            | 471                            | 921                       |
| 2375 x 2250                                      | <b>M</b> 7974   | 1557        | 1557    | 1904        | 306                            | 499                            | 974                       |
| 2438 x 2000                                      | <b>I</b> 8066   | <b>1516</b> | 1516    | 1815        | 280                            | 455                            | 889                       |
| 2438 x 2125                                      | <b>I</b> 8070   | <b>1577</b> | 1577    | <b>1890</b> | 297                            | 484                            | 944                       |
| 2438 x 2250                                      | <b>I</b> 8074   | <b>1586</b> | 1586    | 1945        | 314                            | 512                            | 1000                      |
| 2438 x 2375                                      | <b>I</b> 8079   | 1709        | 1709    | 2037        | 332                            | 541                            | 1055                      |
| 2438 x 2500                                      | <b>I</b> 8082   | 1701        | 1701    | 2132        | 349                            | 570                            | 1111                      |
| 2500 x 1900                                      | <b>M</b> 8262   | 1525        | 1525    | 1826        | 269                            | 437                            | 854                       |
| 2500 x 2000                                      | <b>M</b> 8266   | 1527        | 1527    | 1831        | 286                            | 467                            | 911                       |
| 2500 x 2125                                      | <b>M</b> 8270   | 1527        | 1527    | 1836        | 304                            | 497                            | 968                       |
| 2500 x 2250                                      | <b>M</b> 8274   | 1557        | 1557    | 1904        | 322                            | 525                            | 1026                      |
| 2500 x 2375                                      | <b>M</b> 8279   | 1642        | 1642    | 2025        | 340                            | 555                            | 1083                      |
| 2500 x 2500                                      | <b>M</b> 8282   | 1645        | 1645    | 2023        | 358                            | 583                            | 1140                      |
| 2500 x 2750                                      | <b>M</b> 8290   | 2000        | 2000    | -           | 394                            | 642                            | 1253                      |
| 2591 x 2000                                      | <b>I</b> 8666   | <b>1516</b> | 1516    | 1815        | 297                            | 484                            | 944                       |
| 2591 x 2125                                      | <b>I</b> 8670   | <b>1577</b> | 1577    | <b>1890</b> | 315                            | 515                            | 1003                      |
| 2625 x 2125                                      | <b>M</b> 8770   | 1728        | 1728    | 2099        | 319                            | 521                            | 1017                      |
| 2740 x 2000                                      | <b>I</b> 9066   | 1643        | 1643    | 1989        | 314                            | 512                            | 999                       |
| 2740 x 2125                                      | <b>I</b> 9070   | <b>1699</b> | 1699    | <b>2065</b> | 334                            | 544                            | 1062                      |
| 2750 x 2000                                      | <b>M</b> 9166   | 1753        | 1753    | 2063        | 315                            | 515                            | 1002                      |
| 2750 x 2125                                      | <b>M</b> 9170   | 1809        | 1809    | 2145        | 335                            | 546                            | 1066                      |
| 2750 x 2250                                      | <b>M</b> 9174   | 1819        | 1819    | 2193        | 354                            | 578                            | 1128                      |
| 2750 x 2375                                      | <b>M</b> 9179   | 1868        | 1868    | 2266        | 374                            | 610                            | 1191                      |
| 2750 x 2500                                      | <b>M</b> 9182   | 1950        | 1950    | 2369        | 394                            | 642                            | 1253                      |
| 2896 x 2000                                      | <b>I</b> 9666   | 1717        | 1717    | 2094        | 332                            | 541                            | 1055                      |
| 2896 x 2125                                      | <b>I</b> 9670   | <b>1787</b> | 1787    | 2175        | 352                            | 575                            | 1122                      |
| 3000 x 2000                                      | <b>M</b> 91066  | 1967        | 1967    | 2351        | 343                            | 560                            | 1093                      |
| 3000 x 2125                                      | <b>M</b> 91070  | 1966        | 1966    | 2353        | 365                            | 596                            | 1162                      |
| 3000 x 2250                                      | <b>M</b> 91074  | 1983        | 1983    | 2377        | 387                            | 631                            | 1231                      |
| 3000 x 2375                                      | <b>M</b> 91079  | 2035        | 2035    | 2484        | 408                            | 666                            | 1298                      |
| 3000 x 2500                                      | <b>M</b> 91082  | 2119        | 2119    | 2592        | 429                            | 701                            | 1367                      |
| 3000 x 3000                                      | <b>M</b> 910910 | 2571        | 2571    | 3138        | 515                            | 840                            | 1640                      |
| 3048 x 2000                                      | <b>I</b> 1066   | 1659        | 1659    | 2094        | 349                            | 570                            | 1111                      |
| 3048 x 2125                                      | <b>I</b> 1070   | <b>1719</b> | 1719    | <b>2175</b> | 371                            | 606                            | 1180                      |
| 3250 x 2000                                      | <b>M</b> 10866  | 1978        | 1978    | 2491        | 372                            | 608                            | 1185                      |
| 3250 x 2125                                      | <b>M</b> 10870  | 2035        | 2035    | 2562        | 395                            | 645                            | 1258                      |
| 3250 x 2250                                      | <b>M</b> 10874  | 2080        | 2080    | 2631        | 418                            | 684                            | 1333                      |
| 3353 x 2000                                      | <b>I</b> 1166   | <b>1956</b> | 1956    | 2503        | 383                            | 627                            | 1222                      |
| 3353 x 2125                                      | <b>I</b> 1170   | <b>2035</b> | 2035    | 2605        | 408                            | 666                            | 1298                      |
| 3500 x 2000                                      | <b>M</b> 11666  | 2113        | 2113    | 2647        | 400                            | 654                            | 1276                      |
| 3500 x 2125                                      | <b>M</b> 11670  | 2166        | 2166    | 2718        | 426                            | 694                            | 1356                      |
| 3500 x 2250                                      | <b>M</b> 11674  | 2212        | 2212    | 2800        | 451                            | 735                            | 1435                      |

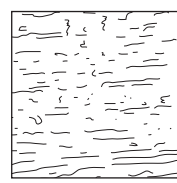

Woodgrain

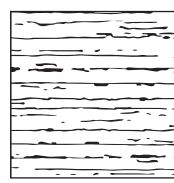

Slategrain<sup>1</sup>

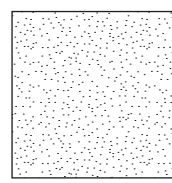

Silkgrain<sup>2</sup>

Linear medium design

Brickwork opening  
Width x Height  
(mm x mm)

Size Code



Premium



Premium



Premium

Surcharge for Standard Colours

Surcharge for Non-Std. Colours

Surcharge for Special RAL

| Brickwork opening<br>Width x Height<br>(mm x mm) | Size Code       | Premium     | Premium | Premium     | Surcharge for Standard Colours | Surcharge for Non-Std. Colours | Surcharge for Special RAL |
|--|-----------------|-------------|---------|-------------|--------------------------------|--------------------------------|---------------------------|
| 3658 x 2000                                      | <b>I</b> 1266   | <b>2300</b> | 2300    | 2825        | 418                            | 684                            | 1333                      |
| 3658 x 2125                                      | <b>I</b> 1270   | <b>2390</b> | 2390    | 2936        | 445                            | 726                            | 1416                      |
| 3750 x 2000                                      | <b>M</b> 12466  | 2229        | 2229    | 2708        | 429                            | 701                            | 1367                      |
| 3750 x 2125                                      | <b>M</b> 12470  | 2295        | 2295    | 2794        | 455                            | 744                            | 1453                      |
| 3750 x 2250                                      | <b>M</b> 12474  | 2340        | 2340    | 2880        | 483                            | 788                            | 1539                      |
| 3962 x 2000                                      | <b>I</b> 1366   | <b>2386</b> | 2386    | 2913        | 453                            | 741                            | 1443                      |
| 3962 x 2125                                      | <b>I</b> 1370   | <b>2476</b> | 2476    | 3023        | 482                            | 786                            | 1534                      |
| 4000 x 2000                                      | <b>M</b> 13266  | 2349        | 2349    | 2849        | 457                            | 747                            | 1458                      |
| 4000 x 2125                                      | <b>M</b> 13270  | 2420        | 2420    | 2920        | 486                            | 794                            | 1549                      |
| 4000 x 2250                                      | <b>M</b> 13274  | 2471        | 2471    | 3015        | 515                            | 840                            | 1640                      |
| 4250 x 2000                                      | <b>M</b> 131166 | 2481        | 2481    | 2970        | 486                            | 794                            | 1549                      |
| 4250 x 2125                                      | <b>M</b> 131170 | 2554        | 2554    | 3063        | 517                            | 844                            | 1645                      |
| 4250 x 2250                                      | <b>M</b> 131174 | 2610        | 2610    | 3152        | 546                            | 893                            | 1742                      |
| 4267 x 2000                                      | <b>I</b> 1466   | <b>2475</b> | 2475    | <b>2997</b> | 488                            | 796                            | 1556                      |
| 4267 x 2125                                      | <b>I</b> 1470   | <b>2574</b> | 2574    | <b>3120</b> | 519                            | 847                            | 1652                      |
| 4420 x 2000                                      | <b>I</b> 14666  | <b>2558</b> | 2558    | 3075        | 506                            | 825                            | 1611                      |
| 4420 x 2125                                      | <b>I</b> 14670  | <b>2661</b> | 2661    | <b>3200</b> | 537                            | 876                            | 1711                      |
| 4500 x 2000                                      | <b>M</b> 14966  | 2608        | 2608    | 3123        | 515                            | 840                            | 1640                      |
| 4500 x 2125                                      | <b>M</b> 14970  | 2684        | 2684    | 3220        | 546                            | 893                            | 1742                      |
| 4500 x 2250                                      | <b>M</b> 14974  | 2737        | 2737    | 3291        | 579                            | 945                            | 1845                      |
| 4572 x 2000                                      | <b>I</b> 1566   | <b>2606</b> | 2606    | 3097        | 522                            | 853                            | 1667                      |
| 4572 x 2125                                      | <b>I</b> 1570   | <b>2708</b> | 2708    | <b>3231</b> | 555                            | 907                            | 1770                      |
| 4725 x 2000                                      | <b>I</b> 15666  | <b>2716</b> | 2716    | 3160        | 540                            | 882                            | 1723                      |
| 4725 x 2125                                      | <b>I</b> 15670  | <b>2823</b> | 2823    | 3281        | 574                            | 937                            | 1830                      |
| 4750 x 2000                                      | <b>M</b> 15766  | 2687        | 2687    | 3187        | 543                            | 887                            | 1731                      |
| 4750 x 2125                                      | <b>M</b> 15770  | 2765        | 2765    | 3291        | 577                            | 942                            | 1840                      |
| 4750 x 2250                                      | <b>M</b> 15774  | 2820        | 2820    | 3383        | 611                            | 997                            | 1947                      |
| 4877 x 2000                                      | <b>I</b> 1666   | <b>2716</b> | 2716    | 3214        | 557                            | 910                            | 1778                      |
| 4877 x 2125                                      | <b>I</b> 1670   | <b>2823</b> | 2823    | <b>3344</b> | 593                            | 967                            | 1888                      |
| 5000 x 2000                                      | <b>M</b> 16566  | 2766        | 2766    | 3311        | 572                            | 933                            | 1822                      |
| 5000 x 2125                                      | <b>M</b> 16570  | 2823        | 2823    | 3399        | 608                            | 992                            | 1936                      |
| 5000 x 2250                                      | <b>M</b> 16574  | 2879        | 2879    | 3488        | 643                            | 1050                           | 2051                      |
| 5000 x 2375                                      | <b>M</b> 16579  | 2939        | 2939    | 3577        | 679                            | 1108                           | 2164                      |
| 5000 x 2500                                      | <b>M</b> 16582  | 2998        | 2998    | 3665        | 714                            | 1167                           | 2277                      |
| 5500 x 2000                                      | <b>M</b> 18166  | 2959        | 2959    | 3575        | 629                            | 1027                           | 2004                      |
| 5500 x 2125                                      | <b>M</b> 18170  | 3040        | 3040    | 3672        | 668                            | 1090                           | 2129                      |
| 5500 x 2250                                      | <b>M</b> 18174  | 3117        | 3117    | 3765        | 707                            | 1156                           | 2255                      |

<sup>1</sup> Slategrain surface texture only available in standard RAL colours and Traffic White (RAL 9016).

<sup>2</sup> Silkgrain surface supplied with tension spring gear up to 3048 mm wide.

Prices in bold are generally a stock item. Non-bold prices require a longer lead-time.

- I** Imperial door sizes.
- M** Metric door sizes. Extended lead time of 4-6 weeks.

- Supplied as standard with tension spring gear. Torsion spring fitting available for Premium doors at £ 107 surcharge.
- Supplied as standard with torsion spring gear. Low headroom fitting available at £ 176 surcharge.

Purpose-made sizes available upon request. Non standard colours also available upon request. Doors supplied without locking as standard (see options on page 67 for handles). For window options please see page 49.

For Slategrain models, the door section has a Slategrain texture but the cover profiles and fascia are smooth.

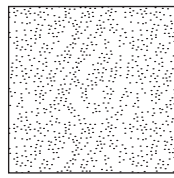
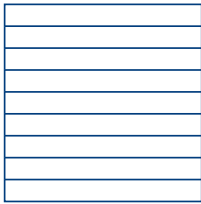
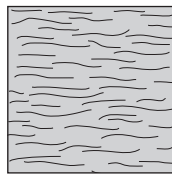
 Sandgrain <sup>1</sup>

 Timber Effect /  
Titan (CH 703)

**Linear medium design**

 Brickwork  
opening  
Width x Height  
(mm x mm)

 Size  
Code

Premium



Premium

 Surcharge  
for  
Standard  
Colours

| Brickwork opening<br>Width x Height<br>(mm x mm) | Size<br>Code | Premium     | Premium           | Surcharge<br>for<br>Standard<br>Colours |
|--|--------------|-------------|-------------------|---|
| 2080 x 2000                                      | I 61066      | 1486        | 1885              | 238                                     |
| 2080 x 2080                                      | I 610610     | <b>1546</b> | 1959 <sup>3</sup> | 248                                     |
| 2134 x 2000                                      | I 7066       | 1486        | 1885 <sup>2</sup> | 245                                     |
| 2134 x 2125                                      | I 7070       | <b>1546</b> | 1959 <sup>2</sup> | 260                                     |
| 2250 x 1900                                      | M 7462       | 1579        | 2020              | 242                                     |
| 2250 x 2000                                      | M 7466       | 1609        | 2057              | 258                                     |
| 2250 x 2125                                      | M 7470       | 1615        | 2058              | 274                                     |
| 2286 x 2000                                      | I 7666       | <b>1486</b> | 1885 <sup>2</sup> | 262                                     |
| 2286 x 2125                                      | I 7670       | <b>1546</b> | 1959 <sup>2</sup> | 279                                     |
| 2286 x 2250                                      | I 7674       | 1617        | 2051 <sup>2</sup> | 294                                     |
| 2286 x 2375                                      | I 7679       | 1689        | 2142              | 310                                     |
| 2286 x 2500                                      | I 7682       | 1752        | 2226              | 327                                     |
| 2375 x 1900                                      | M 7962       | 1579        | 2020              | 255                                     |
| 2375 x 2000                                      | M 7966       | 1585        | 2022              | 272                                     |
| 2375 x 2125                                      | M 7970       | 1588        | 2025              | 288                                     |
| 2375 x 2250                                      | M 7974       | 1650        | 2099              | 306                                     |
| 2438 x 2000                                      | I 8066       | 1570        | 1999 <sup>2</sup> | 280                                     |
| 2438 x 2125                                      | I 8070       | 1638        | 2083 <sup>2</sup> | 297                                     |
| 2438 x 2250                                      | I 8074       | 1690        | 2144 <sup>4</sup> | 314                                     |
| 2438 x 2375                                      | I 8079       | 1763        | 2246              | 332                                     |
| 2438 x 2500                                      | I 8082       | 1844        | 2351              | 349                                     |
| 2500 x 1900                                      | M 8262       | 1579        | 2020              | 269                                     |
| 2500 x 2000                                      | M 8266       | 1585        | 2022              | 286                                     |
| 2500 x 2125                                      | M 8270       | 1588        | 2025              | 304                                     |
| 2500 x 2250                                      | M 8274       | 1650        | 2099              | 322                                     |
| 2500 x 2375                                      | M 8279       | 1752        | 2237              | 340                                     |
| 2500 x 2500                                      | M 8282       | 1755        | 2233              | 358                                     |
| 2500 x 2750                                      | M 8290       | -           | -                 | 394                                     |
| 2591 x 2000                                      | I 8666       | 1570        | 1999              | 297                                     |
| 2591 x 2125                                      | I 8670       | 1638        | 2083 <sup>2</sup> | 315                                     |
| 2625 x 2125                                      | M 8770       | 1807        | 2325              | 319                                     |
| 2740 x 2000                                      | I 9066       | 1712        | 2198              | 314                                     |
| 2740 x 2125                                      | I 9070       | 1783        | 2283 <sup>2</sup> | 334                                     |
| 2750 x 2000                                      | M 9166       | 1777        | 2286              | 315                                     |
| 2750 x 2125                                      | M 9170       | 1847        | 2376              | 335                                     |
| 2750 x 2250                                      | M 9174       | 1888        | 2429              | 354                                     |
| 2750 x 2375                                      | M 9179       | 1954        | 2510              | 374                                     |
| 2750 x 2500                                      | M 9182       | 2039        | 2624              | 394                                     |
| 2896 x 2000                                      | I 9666       | 1800        | 2316              | 332                                     |
| 2896 x 2125                                      | I 9670       | 1874        | 2407              | 352                                     |
| 3000 x 2000                                      | M 91066      | 2015        | 3115              | 343                                     |
| 3000 x 2125                                      | M 91070      | 2017        | 2611              | 365                                     |
| 3000 x 2250                                      | M 91074      | 2037        | 2639              | 387                                     |
| 3000 x 2375                                      | M 91079      | 2131        | 2758              | 408                                     |
| 3000 x 2500                                      | M 91082      | 2222        | 2879              | 429                                     |
| 3000 x 3000                                      | M 910910     | 2464        | 3489              | 515                                     |
| 3048 x 2000                                      | I 1066       | 1800        | 2316              | 349                                     |
| 3048 x 2125                                      | I 1070       | 1874        | 2407 <sup>4</sup> | 371                                     |
| 3250 x 2000                                      | M 10866      | 2127        | 2770              | 372                                     |
| 3250 x 2125                                      | M 10870      | 2188        | 2850              | 395                                     |
| 3250 x 2250                                      | M 10874      | 2252        | 2929              | 418                                     |
| 3353 x 2000                                      | I 1166       | 2142        | 2779              | 383                                     |
| 3353 x 2125                                      | I 1170       | 2224        | 2892              | 408                                     |
| 3500 x 2000                                      | M 11666      | 2258        | 2949              | 400                                     |
| 3500 x 2125                                      | M 11670      | 2319        | 3028              | 426                                     |
| 3500 x 2250                                      | M 11674      | 2389        | 3118              | 451                                     |
| 3658 x 2000                                      | I 1266       | 2408        | 3144              | 418                                     |
| 3658 x 2125                                      | I 1270       | 2503        | 3268 <sup>4</sup> | 445                                     |



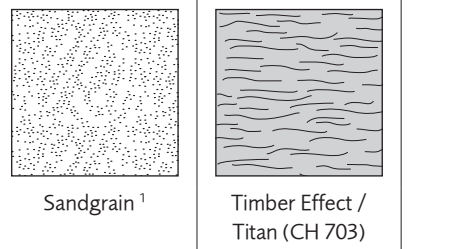

Linear medium design

Brickwork opening  
Width x Height  
(mm x mm)

Size Code



Premium

Premium

Surcharge for Standard Colours

| Brickwork opening<br>Width x Height<br>(mm x mm) | Size Code |        | Premium     | Premium           | Surcharge for Standard Colours |
|--|-----------|--------|-------------|-------------------|--------------------------------|
| 3750 x 2000                                      | <b>M</b>  | 12466  | 2309        | 3018              | 429                            |
| 3750 x 2125                                      | <b>M</b>  | 12470  | 2383        | 3115              | 455                            |
| 3750 x 2250                                      | <b>M</b>  | 12474  | 2452        | 3210              | 483                            |
| 3962 x 2000                                      | <b>I</b>  | 1366   | 2478        | 3243              | 453                            |
| 3962 x 2125                                      | <b>I</b>  | 1370   | 2568        | 3366 <sup>4</sup> | 482                            |
| 4000 x 2000                                      | <b>M</b>  | 13266  | 2423        | 3178              | 457                            |
| 4000 x 2125                                      | <b>M</b>  | 13270  | 2484        | 3258              | 486                            |
| 4000 x 2250                                      | <b>M</b>  | 13274  | 2568        | 3363              | 515                            |
| 4250 x 2000                                      | <b>M</b>  | 131166 | 2524        | 3315              | 486                            |
| 4250 x 2125                                      | <b>M</b>  | 131170 | 2602        | 3419              | 517                            |
| 4250 x 2250                                      | <b>M</b>  | 131174 | 2679        | 3518              | 546                            |
| 4267 x 2000                                      | <b>I</b>  | 1466   | 2549        | 3339 <sup>2</sup> | 488                            |
| 4267 x 2125                                      | <b>I</b>  | 1470   | <b>2651</b> | 3477 <sup>2</sup> | 519                            |
| 4420 x 2000                                      | <b>I</b>  | 14666  | 2613        | 3428              | 506                            |
| 4420 x 2125                                      | <b>I</b>  | 14670  | 2719        | 3568 <sup>2</sup> | 537                            |
| 4500 x 2000                                      | <b>M</b>  | 14966  | 2650        | 3489              | 515                            |
| 4500 x 2125                                      | <b>M</b>  | 14970  | 2734        | 3597              | 546                            |
| 4500 x 2250                                      | <b>M</b>  | 14974  | 2794        | 3676              | 579                            |
| 4572 x 2000                                      | <b>I</b>  | 1566   | 2631        | 3452              | 522                            |
| 4572 x 2125                                      | <b>I</b>  | 1570   | 2745        | 3601              | 555                            |
| 4725 x 2000                                      | <b>I</b>  | 15666  | 2680        | 3524              | 540                            |
| 4725 x 2125                                      | <b>I</b>  | 15670  | 2787        | 3660 <sup>4</sup> | 574                            |
| 4750 x 2000                                      | <b>M</b>  | 15766  | 2703        | 3562              | 543                            |
| 4750 x 2125                                      | <b>M</b>  | 15770  | 2791        | 3679              | 577                            |
| 4750 x 2250                                      | <b>M</b>  | 15774  | 2870        | 3780              | 611                            |
| 4877 x 2000                                      | <b>I</b>  | 1666   | 2731        | 3586              | 557                            |
| 4877 x 2125                                      | <b>I</b>  | 1670   | <b>2836</b> | 3730 <sup>2</sup> | 593                            |
| 5000 x 2000                                      | <b>M</b>  | 16566  | 2806        | 3703              | 572                            |
| 5000 x 2125                                      | <b>M</b>  | 16570  | 2882        | 3801              | 608                            |
| 5000 x 2250                                      | <b>M</b>  | 16574  | 2953        | 3900              | 643                            |
| 5000 x 2375                                      | <b>M</b>  | 16579  | 3032        | 3999              | 679                            |
| 5000 x 2500                                      | <b>M</b>  | 16582  | 3103        | 4096              | 714                            |
| 5500 x 2000                                      | <b>M</b>  | 18166  | 3023        | 4002              | 629                            |
| 5500 x 2125                                      | <b>M</b>  | 18170  | 3105        | 4110              | 668                            |
| 5500 x 2250                                      | <b>M</b>  | 18174  | 3186        | 4215              | 707                            |

<sup>1</sup> Sandgrain surface available in Traffic White (RAL 9016) and Anthracite Grey (RAL 7016).

<sup>2</sup> Available as stock door in Rosewood or Golden Oak timber effect.

<sup>3</sup> Available as stock door in Rosewood timber effect.

<sup>4</sup> Available as stock door in Golden Oak timber effect.

Prices in bold are generally a stock item. Non-bold prices require a longer lead-time.

**I** Imperial door sizes.

**M** Metric door sizes. Extended lead time of 4-6 weeks.

Supplied as standard with tension spring gear. Torsion spring fitting available for Premium doors at £ 107 surcharge.

Supplied as standard with torsion spring gear. Low headroom fitting available at £ 176 surcharge.





Purpose-made sizes available upon request. Non standard colours also available upon request. Doors supplied without locking as standard (see options on page 67 for handles). For window options please see page 49.





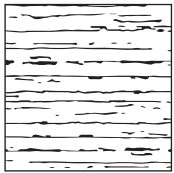
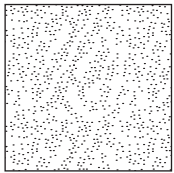
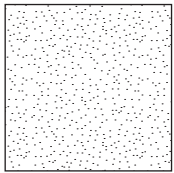
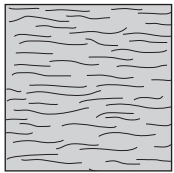

## Linear large design

 Brickwork opening  
Width x Height  
(mm x mm)

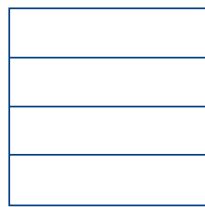
 Size  
Code

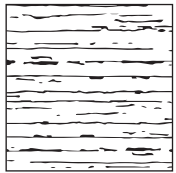
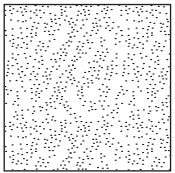
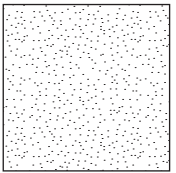
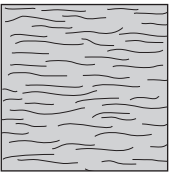
|             |          |  |  |  |  |   |   |                                 |
|-------------|----------|---|---|--|---|---|---|---------------------------------|
|             |          | Slategrain <sup>1</sup>   | Sandgrain <sup>2</sup>  | Silkgrain <sup>3</sup>   | Timber Effect /<br>Titan (CH 703)   |   |   |                                 |
|             |          |  |  |   |  | Surcharge<br>for<br>Standard<br>Colours | Surcharge<br>for<br>Non-Std.<br>Colours | Surcharge<br>for Special<br>RAL |
|             |          | Premium   | Premium   | Premium  | Premium   |   |   |                                 |
| 2080 x 2000 | I 61066  | 1529  | 1731  | 1919   | 2107  | 238                                     | 390                                     | 759                             |
| 2080 x 2080 | I 610610 | 1586  | 1754  | 1943   | 2131  | 248                                     | 405                                     | 789                             |
| 2134 x 2000 | I 7066   | 1586  | 1731  | <b>1919</b>  | 2107  | 245                                     | 399                                     | 778                             |
| 2134 x 2125 | I 7070   | 1641  | <b>1754</b>   | <b>1943</b>  | 2131  | 260                                     | 424                                     | 827                             |
| 2250 x 1900 | M 7462   | 1691  | 1828  | 2034   | 2237  | 242                                     | 395                                     | 768                             |
| 2250 x 2000 | M 7466   | 1737  | 1865  | 2070   | 2274  | 258                                     | 421                                     | 820                             |
| 2250 x 2125 | M 7470   | 1737  | 1866  | 2074   | 2276  | 274                                     | 447                                     | 872                             |
| 2286 x 2000 | I 7666   | 1586  | <b>1731</b>   | <b>1919</b>  | 2107  | 262                                     | 428                                     | 834                             |
| 2286 x 2125 | I 7670   | 1641  | <b>1754</b>   | <b>1943</b>  | <b>2131</b> <sup>4</sup>  | 279                                     | 454                                     | 885                             |
| 2286 x 2250 | I 7674   | 1660  | <b>1827</b>   | <b>2029</b>  | 2227  | 294                                     | 481                                     | 938                             |
| 2286 x 2375 | I 7679   | 1794  | 1839  | 2037   | 2234  | 310                                     | 507                                     | 990                             |
| 2286 x 2500 | I 7682   | 1788  | 1888  | 2088   | 2289  | 327                                     | 535                                     | 1042                            |
| 2375 x 1900 | M 7962   | 1691  | 1828  | 2034   | 2237  | 255                                     | 417                                     | 812                             |
| 2375 x 2000 | M 7966   | 1687  | 1837  | 2040   | 2241  | 272                                     | 445                                     | 867                             |
| 2375 x 2125 | M 7970   | 1690  | 1841  | 2043   | 2242  | 288                                     | 471                                     | 921                             |
| 2375 x 2250 | M 7974   | 1717  | 1898  | 2103   | 2310  | 306                                     | 499                                     | 974                             |
| 2438 x 2000 | I 8066   | 1670  | 1828  | 2027   | 2228  | 280                                     | 455                                     | 889                             |
| 2438 x 2125 | I 8070   | 1736  | <b>1861</b>   | <b>2069</b>  | 2273 <sup>5</sup>   | 297                                     | 484                                     | 944                             |
| 2438 x 2250 | I 8074   | 1746  | 1954  | 2169   | 2384  | 314                                     | 512                                     | 1000                            |
| 2438 x 2375 | I 8079   | 1883  | 2005  | 2225   | 2445  | 332                                     | 541                                     | 1055                            |
| 2438 x 2500 | I 8082   | 1875  | 2061  | 2286   | 2512  | 349                                     | 570                                     | 1111                            |
| 2500 x 1900 | M 8262   | 1691  | 1828  | 2034   | 2237  | 269                                     | 437                                     | 854                             |
| 2500 x 2000 | M 8266   | 1687  | 1837  | 2040   | 2241  | 286                                     | 467                                     | 911                             |
| 2500 x 2125 | M 8270   | 1690  | 1841  | 2043   | 2242  | 304                                     | 497                                     | 968                             |
| 2500 x 2250 | M 8274   | 1717  | 1898  | 2103   | 2310  | 322                                     | 525                                     | 1026                            |
| 2500 x 2375 | M 8279   | 1817  | 1988  | 2206   | 2422  | 340                                     | 555                                     | 1083                            |
| 2500 x 2500 | M 8282   | 1816  | 1991  | 2207   | 2421  | 358                                     | 583                                     | 1140                            |
| 2500 x 2750 | M 8290   | 2212  | -   | -  | -   | 394                                     | 642                                     | 1253                            |
| 2591 x 2000 | I 8666   | 1670  | 1828  | 2027   | 2228  | 297                                     | 484                                     | 944                             |
| 2591 x 2125 | I 8670   | 1736  | 1861  | <b>2069</b>  | 2273  | 315                                     | 515                                     | 1003                            |
| 2625 x 2125 | M 8770   | 1917  | 2115  | 2358   | 2598  | 319                                     | 521                                     | 1017                            |
| 2740 x 2000 | I 9066   | 1814  | 2006  | <b>2231</b>  | 2458  | 314                                     | 512                                     | 999                             |
| 2740 x 2125 | I 9070   | 1877  | 2033  | 2263   | 2493  | 334                                     | 544                                     | 1062                            |
| 2750 x 2000 | M 9166   | 1945  | 2134  | 2379   | 2622  | 315                                     | 515                                     | 1002                            |
| 2750 x 2125 | M 9170   | 2008  | 2180  | 2429   | 2676  | 335                                     | 546                                     | 1066                            |
| 2750 x 2250 | M 9174   | 2015  | 2292  | 2553   | 2814  | 354                                     | 578                                     | 1128                            |
| 2750 x 2375 | M 9179   | 2066  | 2343  | 2612   | 2879  | 374                                     | 610                                     | 1191                            |
| 2750 x 2500 | M 9182   | 2165  | 2395  | 2674   | 2947  | 394                                     | 642                                     | 1253                            |
| 2896 x 2000 | I 9666   | 1898  | 2114  | 2356   | 2598  | 332                                     | 541                                     | 1055                            |
| 2896 x 2125 | I 9670   | 1977  | 2146  | 2390   | 2634  | 352                                     | 575                                     | 1122                            |
| 3000 x 2000 | M 91066  | 2191  | 2228  | 2487   | 2743  | 343                                     | 560                                     | 1093                            |
| 3000 x 2125 | M 91070  | 2186  | 2228  | 2484   | 2739  | 365                                     | 596                                     | 1162                            |
| 3000 x 2250 | M 91074  | 2205  | 2315  | 2583   | 2847  | 387                                     | 631                                     | 1231                            |
| 3000 x 2375 | M 91079  | 2261  | 2427  | 2711   | 2991  | 408                                     | 666                                     | 1298                            |
| 3000 x 2500 | M 91082  | 2356  | 2466  | 2749   | 3032  | 429                                     | 701                                     | 1367                            |
| 3000 x 3000 | M 910910 | 2870  | 3325  | 3725   | 4122  | 515                                     | 840                                     | 1640                            |
| 3048 x 2000 | I 1066   | 1833  | 2114  | 2356   | 2598  | 349                                     | 570                                     | 1111                            |
| 3048 x 2125 | I 1070   | 1899  | 2146  | <b>2390</b>  | 2634  | 371                                     | 606                                     | 1180                            |
| 3250 x 2000 | M 10866  | 2207  | 2549  | 2853   | 3156  | 372                                     | 608                                     | 1185                            |
| 3250 x 2125 | M 10870  | 2267  | 2588  | 2898   | 3205  | 395                                     | 645                                     | 1258                            |
| 3250 x 2250 | M 10874  | 2316  | 2640  | 2953   | 3264  | 418                                     | 684                                     | 1333                            |
| 3353 x 2000 | I 1166   | 2172  | 2503  | 2803   | 3100  | 383                                     | 627                                     | 1222                            |
| 3353 x 2125 | I 1170   | 2259  | 2543  | 2845   | 3145  | 408                                     | 666                                     | 1298                            |
| 3500 x 2000 | M 11666  | 2357  | 2606  | 2919   | 3230  | 400                                     | 654                                     | 1276                            |
| 3500 x 2125 | M 11670  | 2417  | 2656  | 2976   | 3292  | 426                                     | 694                                     | 1356                            |
| 3500 x 2250 | M 11674  | 2466  | 2698  | 3024   | 3343  | 451                                     | 735                                     | 1435                            |
| 3658 x 2000 | I 1266   | 2564  | 2824  | 3169   | 3511  | 418                                     | 684                                     | 1333                            |
| 3658 x 2125 | I 1270   | 2665  | 2876  | 3227   | 3575  | 445                                     | 726                                     | 1416                            |
| 3750 x 2000 | M 12466  | 2495  | 2650  | 2971   | 3287  | 429                                     | 701                                     | 1367                            |



|  |                 |  |  |  |  |                                |                                |                           |
|--|-----------------|---|---|--|---|--------------------------------|--------------------------------|---------------------------|
| Linear large design                        |                 |  |  |   |  |                                |                                |                           |
| Brickwork opening Width x Height (mm x mm) | Size Code       | Premium   | Premium   | Premium  | Premium   | Surcharge for Standard Colours | Surcharge for Non-Std. Colours | Surcharge for Special RAL |
| 3750 x 2125                                | <b>M</b> 12470  | 2563  | 2673  | 2994   | 3311  | 455                            | 744                            | 1453                      |
| 3750 x 2250                                | <b>M</b> 12474  | 2619  | 2737  | 3065   | 3390  | 483                            | 788                            | 1539                      |
| 3962 x 2000                                | <b>I</b> 1366   | 2661  | 2911  | 3270   | 3626  | 453                            | 741                            | 1443                      |
| 3962 x 2125                                | <b>I</b> 1370   | 2763  | 2955  | 3317   | 3676  | 482                            | 786                            | 1534                      |
| 4000 x 2000                                | <b>M</b> 13266  | 2629  | 2850  | 3197   | 3542  | 457                            | 747                            | 1458                      |
| 4000 x 2125                                | <b>M</b> 13270  | 2708  | 2922  | 3282   | 3635  | 486                            | 794                            | 1549                      |
| 4000 x 2250                                | <b>M</b> 13274  | 2763  | 2993  | 3358   | 3720  | 515                            | 840                            | 1640                      |
| 4250 x 2000                                | <b>M</b> 131166 | 2777  | 3018  | 3388   | 3757  | 486                            | 794                            | 1549                      |
| 4250 x 2125                                | <b>M</b> 131170 | 2860  | 3078  | 3458   | 3833  | 517                            | 844                            | 1645                      |
| 4250 x 2250                                | <b>M</b> 131174 | 2921  | 3134  | 3522   | 3903  | 546                            | 893                            | 1742                      |
| 4267 x 2000                                | <b>I</b> 1466   | 2764  | 2998  | <b>3370</b>  | 3738  | 488                            | 796                            | 1556                      |
| 4267 x 2125                                | <b>I</b> 1470   | 2875  | <b>3049</b>   | <b>3426</b>  | 3799 <sup>6</sup>   | 519                            | 847                            | 1652                      |
| 4420 x 2000                                | <b>I</b> 14666  | 2857  | 3081  | <b>3464</b>  | 3843  | 506                            | 825                            | 1611                      |
| 4420 x 2125                                | <b>I</b> 14670  | 2973  | 3132  | <b>3517</b>  | 3902  | 537                            | 876                            | 1711                      |
| 4500 x 2000                                | <b>M</b> 14966  | 2924  | 3075  | 3454   | 3831  | 515                            | 840                            | 1640                      |
| 4500 x 2125                                | <b>M</b> 14970  | 3012  | 3173  | 3566   | 3956  | 546                            | 893                            | 1742                      |
| 4500 x 2250                                | <b>M</b> 14974  | 3070  | 3244  | 3651   | 4049  | 579                            | 945                            | 1845                      |
| 4572 x 2000                                | <b>I</b> 1566   | 2910  | 3116  | 3501   | 3886  | 522                            | 853                            | 1667                      |
| 4572 x 2125                                | <b>I</b> 1570   | 3027  | 3166  | <b>3557</b>  | 3947  | 555                            | 907                            | 1770                      |
| 4725 x 2000                                | <b>I</b> 15666  | 3038  | 3169  | 3565   | 3958  | 540                            | 882                            | 1723                      |
| 4725 x 2125                                | <b>I</b> 15670  | 3158  | 3225  | 3627   | 4027  | 574                            | 937                            | 1830                      |
| 4750 x 2000                                | <b>M</b> 15766  | 3014  | 3206  | 3605   | 4000  | 543                            | 887                            | 1731                      |
| 4750 x 2125                                | <b>M</b> 15770  | 3107  | 3281  | 3690   | 4095  | 577                            | 942                            | 1840                      |
| 4750 x 2250                                | <b>M</b> 15774  | 3160  | 3357  | 3777   | 4190  | 611                            | 997                            | 1947                      |
| 4877 x 2000                                | <b>I</b> 1666   | 2910  | 3229  | 3629   | 4030  | 557                            | 910                            | 1778                      |
| 4877 x 2125                                | <b>I</b> 1670   | 3027  | 3284  | <b>3693</b>  | 4101  | 593                            | 967                            | 1888                      |
| 5000 x 2000                                | <b>M</b> 16566  | 3108  | 3328  | 3747   | 4160  | 572                            | 933                            | 1822                      |
| 5000 x 2125                                | <b>M</b> 16570  | 3172  | 3398  | 3828   | 4249  | 608                            | 992                            | 1936                      |
| 5000 x 2250                                | <b>M</b> 16574  | 3233  | 3476  | 3915   | 4344  | 643                            | 1050                           | 2051                      |
| 5000 x 2375                                | <b>M</b> 16579  | 3295  | 3559  | 4005   | 4444  | 679                            | 1108                           | 2164                      |
| 5000 x 2500                                | <b>M</b> 16582  | 3356  | 3648  | 4099   | 4548  | 714                            | 1167                           | 2277                      |
| 5500 x 2000                                | <b>M</b> 18166  | 3330  | 3462  | 3897   | 4329  | 629                            | 1027                           | 2004                      |
| 5500 x 2125                                | <b>M</b> 18170  | 3418  | 3529  | 3976   | 4416  | 668                            | 1090                           | 2129                      |
| 5500 x 2250                                | <b>M</b> 18174  | 3503  | 3651  | 4113   | 4568  | 707                            | 1156                           | 2255                      |

<sup>1</sup> Slategrain surface texture only available in standard RAL colours and Traffic White (RAL 9016).

<sup>2</sup> Sandgrain surface available in Traffic White (RAL 9016) and Anthracite Grey (RAL 7016).

<sup>3</sup> Silkgrain surface supplied with tension spring gear up to 3048 mm wide.

<sup>4</sup> Available as stock door in Rosewood or Titan.

<sup>5</sup> Available as stock door in Golden Oak timber effect.

<sup>6</sup> Available as stock door in Rosewood or Golden Oak timber effect.

Prices in bold are generally a stock item. Non-bold prices require a longer lead-time.

**I** Imperial door sizes.

**M** Metric door sizes. Extended lead time of 4-6 weeks.

 Supplied as standard with tension spring gear. Torsion spring fitting available for Premium doors at £ 107 surcharge.

 Supplied as standard with torsion spring gear. Low headroom fitting available at £ 176 surcharge.

Purpose-made sizes available upon request. Non standard colours also available upon request. Doors supplied without locking as standard (see options on page 67 for handles). For window options please see page 49.

For Slategrain models, the door section has a Slategrain texture but the cover profiles and fascia are smooth.

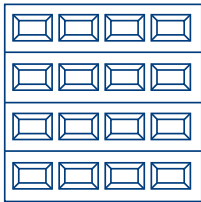

**Woodgrain Premium (42 mm insulated)**

**Georgian design**

Door width

| Door Height | 2000 | 2250 | 2375 | 2500 | 2750 | 3000 | 3250 | 3500 | 3750 | 4000 | 4250 | 4500 | 4750 | 5000 | 5250 | 5500 |
|-------------|------|------|------|------|------|------|------|------|------|------|------|------|------|------|------|------|
| 1900        | 1995 | 2003 | 2034 | 2217 | 2314 | 2604 | 2772 | 3030 | 3077 | 3138 | 3223 | 2261 | 2448 | 3448 | 3544 |      |
| 2000        | 2015 | 2024 | 2052 | 2273 | 2445 | 2637 | 2834 | 3070 | 3136 | 3223 | 3309 | 3383 | 3451 | 3521 | 3618 |      |
| 2080        | 2026 | 2037 | 2063 | 2304 | 2481 | 2653 | 2901 | 3105 | 3189 | 3309 | 3399 | 3470 | 3517 | 3592 | 3691 |      |
| 2125        | 2026 | 2037 | 2063 | 2304 | 2481 | 2653 | 2901 | 3105 | 3189 | 3309 | 3399 | 3470 | 3517 | 3592 | 3691 |      |
| 2205        | 2143 | 2165 | 2246 | 2349 | 2639 | 2682 | 2979 | 3178 | 3247 | 3393 | 3500 | 3550 | 3596 | 3671 | 3774 |      |
| 2250        | 2057 | 2080 | 2156 | 2256 | 2532 | 2682 | 2979 | 3178 | 3247 | 3393 | 3500 | 3550 | 3596 | 3671 | 3774 |      |
| 2375        | 2082 | 2118 | 2185 | 2301 | 2581 | 2752 | 3033 | 3244 | 3309 | 3448 | 3584 | 3644 | 3785 | 3864 | 3973 |      |
| 2500        | 2123 | 2172 | 2221 | 2390 | 2675 | 2840 | 3087 | 3309 | 3374 | 3522 | 3632 | 3740 | 3971 | 4057 | 4172 |      |
| 2600        | 2185 | 2230 | 2262 | 2483 | 2783 | 2934 | 3177 | 3377 | 3441 | 3609 | 3812 | 3926 | 4168 | 4260 | 4379 |      |
| 2750        | 2351 | 2402 | 2412 | 2719 | 2961 | 3014 | 3229 | 3441 | 3590 | 3764 | 3977 | 4100 | 4355 | 4452 | 4577 |      |
| 2850        | 2646 | 2704 | 2891 | 3138 | 3355 | 3397 | 3522 | 3587 | 3747 | 3929 | 4158 | 4279 | 4546 | 4649 | -    |      |
| 3000        | 2924 | 2970 | 3038 | 3223 | 3438 | 3478 | 3631 | 3735 | 3903 | 4095 | 4327 | 4453 | 4730 | -    | -    |      |

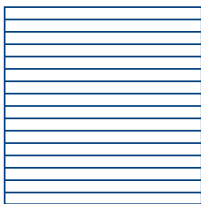

**Woodgrain Premium (42 mm insulated)**

**Linear small design**

Door width

| Door Height | 2000 | 2250 | 2375 | 2500 | 2750 | 3000 | 3250 | 3500 | 3750 | 4000 | 4250 | 4500 | 4750 | 5000 | 5250 | 5500 |
|-------------|------|------|------|------|------|------|------|------|------|------|------|------|------|------|------|------|
| 1900        | 1492 | 1539 | 1583 | 1772 | 1991 | 2117 | 2291 | 2298 | 2398 | 2501 | 2597 | 2687 | 2779 | 2930 | 3040 |      |
| 2000        | 1547 | 1588 | 1632 | 1841 | 2052 | 2180 | 2362 | 2372 | 2467 | 2598 | 2693 | 2786 | 2858 | 3015 | 3130 |      |
| 2080        | 1591 | 1630 | 1675 | 1890 | 2107 | 2241 | 2428 | 2449 | 2537 | 2674 | 2784 | 2880 | 2937 | 3098 | 3213 |      |
| 2125        | 1591 | 1630 | 1675 | 1890 | 2107 | 2241 | 2428 | 2449 | 2537 | 2674 | 2784 | 2880 | 2937 | 3098 | 3213 |      |
| 2205        | 1626 | 1667 | 1697 | 1911 | 2142 | 2300 | 2501 | 2519 | 2600 | 2756 | 2886 | 2955 | 3027 | 3195 | 3317 |      |
| 2250        | 1626 | 1667 | 1697 | 1911 | 2142 | 2300 | 2501 | 2519 | 2600 | 2756 | 2886 | 2955 | 3027 | 3195 | 3317 |      |
| 2375        | 1661 | 1705 | 1726 | 1955 | 2181 | 2356 | 2551 | 2589 | 2669 | 2833 | 2983 | 3069 | 3189 | 3362 | 3491 |      |
| 2500        | 1691 | 1733 | 1766 | 2007 | 2223 | 2450 | 2633 | 2655 | 2737 | 2918 | 3043 | 3177 | 3344 | 3532 | 3662 |      |
| 2600        | 1742 | 1787 | 1832 | 2108 | 2315 | 2543 | 2696 | 2737 | 2804 | 3001 | 3195 | 3332 | 3508 | 3704 | 3843 |      |
| 2750        | 1911 | 1965 | 2021 | 2341 | 2576 | 2634 | 2770 | 2808 | 2923 | 3134 | 3334 | 3479 | 3663 | 3866 | 4011 |      |
| 2850        | 2106 | 2156 | 2209 | 2438 | 2672 | 2723 | 2882 | 2931 | 3050 | 3267 | 3479 | 3633 | 3826 | 4035 | -    |      |
| 3000        | 2186 | 2253 | 2310 | 2533 | 2772 | 2812 | 2996 | 3047 | 3176 | 3400 | 3619 | 3781 | 3983 | -    | -    |      |

Supplied with tensions spring as standard. Optional torsion spring available at additional cost, please see page 67.

These doors are only available with torsion spring.

For further options please see page 67.

Only fixed door heights are available on Georgian Premium sectional doors.

For intermediate heights, between designated heights in the table above please add £ 150 (for example, a required height of 2175 mm would be taken from the designated height 2205 mm).



**Woodgrain Premium (42 mm insulated)**

**Linear medium design**

Door width

| Door Height | 2000 | 2250 | 2375 | 2500 | 2750 | 3000 | 3250 | 3500 | 3750 | 4000 | 4250 | 4500 | 4750 | 5000 | 5250 | 5500 |
|-------------|------|------|------|------|------|------|------|------|------|------|------|------|------|------|------|------|
| 1900        | 1492 | 1539 | 1583 | 1773 | 1991 | 2117 | 2291 | 2298 | 2397 | 2501 | 2597 | 2687 | 2779 | 2930 | 3041 |      |
| 2000        | 1546 | 1588 | 1630 | 1839 | 2050 | 2179 | 2360 | 2370 | 2466 | 2596 | 2692 | 2784 | 2857 | 3015 | 3129 |      |
| 2080        | 1592 | 1629 | 1675 | 1890 | 2106 | 2241 | 2427 | 2450 | 2537 | 2673 | 2783 | 2879 | 2937 | 3098 | 3213 |      |
| 2125        | 1592 | 1629 | 1675 | 1890 | 2106 | 2241 | 2427 | 2450 | 2537 | 2673 | 2783 | 2879 | 2937 | 3098 | 3213 |      |
| 2205        | 1626 | 1666 | 1696 | 1910 | 2141 | 2300 | 2501 | 2519 | 2599 | 2755 | 2886 | 2954 | 3026 | 3195 | 3316 |      |
| 2250        | 1626 | 1666 | 1696 | 1910 | 2141 | 2300 | 2501 | 2519 | 2599 | 2755 | 2886 | 2954 | 3026 | 3195 | 3316 |      |
| 2375        | 1660 | 1704 | 1725 | 1954 | 2180 | 2355 | 2551 | 2589 | 2669 | 2832 | 2982 | 3069 | 3188 | 3362 | 3490 |      |
| 2500        | 1689 | 1732 | 1766 | 2007 | 2221 | 2449 | 2631 | 2654 | 2736 | 2917 | 3042 | 3176 | 3343 | 3531 | 3661 |      |
| 2600        | 1741 | 1787 | 1831 | 2106 | 2314 | 2542 | 2695 | 2736 | 2803 | 3000 | 3193 | 3331 | 3508 | 3702 | 3841 |      |
| 2750        | 1910 | 1964 | 2020 | 2339 | 2575 | 2634 | 2769 | 2807 | 2924 | 3134 | 3333 | 3478 | 3663 | 3866 | 4011 |      |
| 2850        | 2104 | 2155 | 2207 | 2436 | 2670 | 2722 | 2881 | 2928 | 3048 | 3266 | 3478 | 3632 | 3825 | 4034 | -    |      |
| 3000        | 2184 | 2251 | 2308 | 2531 | 2772 | 2811 | 2995 | 3045 | 3175 | 3400 | 3617 | 3779 | 3983 | -    | -    |      |

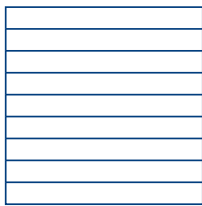

**Slategrain Premium (42 mm insulated)**

**Linear medium design**

Door width

| Door Height | 2000 | 2250 | 2375 | 2500 | 2750 | 3000 | 3250 | 3500 | 3750 | 4000 | 4250 | 4500 | 4750 | 5000 | 5250 | 5500 |
|-------------|------|------|------|------|------|------|------|------|------|------|------|------|------|------|------|------|
| 1900        | 1492 | 1539 | 1583 | 1773 | 1991 | 2117 | 2291 | 2298 | 2397 | 2501 | 2597 | 2687 | 2779 | 2930 | 3041 |      |
| 2000        | 1546 | 1588 | 1630 | 1839 | 2050 | 2179 | 2360 | 2370 | 2466 | 2596 | 2692 | 2784 | 2857 | 3015 | 3129 |      |
| 2080        | 1592 | 1629 | 1675 | 1890 | 2106 | 2241 | 2427 | 2450 | 2537 | 2673 | 2783 | 2879 | 2937 | 3098 | 3213 |      |
| 2125        | 1592 | 1629 | 1675 | 1890 | 2106 | 2241 | 2427 | 2450 | 2537 | 2673 | 2783 | 2879 | 2937 | 3098 | 3213 |      |
| 2205        | 1626 | 1666 | 1696 | 1910 | 2141 | 2300 | 2501 | 2519 | 2599 | 2755 | 2886 | 2954 | 3026 | 3195 | 3316 |      |
| 2250        | 1626 | 1666 | 1696 | 1910 | 2141 | 2300 | 2501 | 2519 | 2599 | 2755 | 2886 | 2954 | 3026 | 3195 | 3316 |      |
| 2375        | 1660 | 1704 | 1725 | 1954 | 2180 | 2355 | 2551 | 2589 | 2669 | 2832 | 2982 | 3069 | 3188 | 3362 | 3490 |      |
| 2500        | 1689 | 1732 | 1766 | 2007 | 2221 | 2449 | 2631 | 2654 | 2736 | 2917 | 3042 | 3176 | 3343 | 3531 | 3661 |      |
| 2600        | 1741 | 1787 | 1831 | 2106 | 2314 | 2542 | 2695 | 2736 | 2803 | 3000 | 3193 | 3331 | 3508 | 3702 | 3841 |      |
| 2750        | 1910 | 1964 | 2020 | 2339 | 2575 | 2634 | 2769 | 2807 | 2924 | 3134 | 3333 | 3478 | 3663 | 3866 | 4011 |      |
| 2850        | 2104 | 2155 | 2207 | 2436 | 2670 | 2722 | 2881 | 2928 | 3048 | 3266 | 3478 | 3632 | 3825 | 4034 | -    |      |
| 3000        | 2184 | 2251 | 2308 | 2531 | 2772 | 2811 | 2995 | 3045 | 3175 | 3400 | 3617 | 3779 | 3983 | -    | -    |      |

Supplied with tensions spring as standard. Optional torsion spring available at additional cost, please see page 67.

These doors are only available with torsion spring.

For further options please see page 67.

For intermediate heights, between designated heights in the table above please add £ 150 (for example, a required height of 2175 mm would be taken from the designated height 2205 mm).

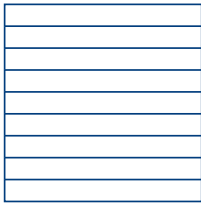

**Sandgrain Premium (42 mm insulated)**

**Linear medium design**

| Door Height | Door width |      |      |      |      |      |      |      |      |      |      |      |      |      |      |      |   |
|-------------|------------|------|------|------|------|------|------|------|------|------|------|------|------|------|------|------|---|
|             | 2000       | 2250 | 2375 | 2500 | 2750 | 3000 | 3250 | 3500 | 3750 | 4000 | 4250 | 4500 | 4750 | 5000 | 5250 | 5500 |   |
| 1900        | 1529       | 1580 | 1624 | 1825 | 2053 | 2199 | 2375 | 2380 | 2486 | 2589 | 2684 | 2782 | 2877 | 2983 | 3095 |      |   |
| 2000        | 1589       | 1635 | 1676 | 1898 | 2121 | 2263 | 2449 | 2460 | 2558 | 2693 | 2792 | 2884 | 2962 | 3070 | 3184 |      |   |
| 2080        | 1641       | 1679 | 1724 | 1950 | 2174 | 2326 | 2519 | 3197 | 2629 | 2773 | 2882 | 2978 | 3042 | 3154 | 3270 |      |   |
| 2125        | 1641       | 1679 | 1724 | 1950 | 2174 | 2326 | 2519 | 2538 | 2629 | 2773 | 2882 | 2978 | 3042 | 3154 | 3270 |      |   |
| 2205        | 1701       | 1740 | 1769 | 2005 | 2241 | 2395 | 2591 | 2612 | 2699 | 2856 | 2991 | 3064 | 3139 | 3257 | 3380 |      |   |
| 2250        | 1701       | 1740 | 1769 | 2005 | 2241 | 2395 | 2591 | 2612 | 2699 | 2856 | 2991 | 3064 | 3139 | 3257 | 3380 |      |   |
| 2375        | 1756       | 1801 | 1837 | 2070 | 2302 | 2447 | 2647 | 2686 | 2770 | 2939 | 3092 | 3178 | 3300 | 3426 | 3555 |      |   |
| 2500        | 1813       | 1856 | 1900 | 2164 | 2401 | 2546 | 2729 | 2757 | 2834 | 3022 | 3151 | 3290 | 3463 | 3598 | 3734 |      |   |
| 2600        | -          | -    | -    | -    | -    | -    | -    | -    | -    | -    | -    | -    | -    | -    | -    | -    | - |
| 2750        | 2108       | 2169 | 2228 | 2435 | 2658 | 2696 | 2862 | 2917 | 3316 | 3507 | 3616 | 3780 | 3868 | 4014 | 4172 |      |   |
| 2850        | -          | -    | -    | -    | -    | -    | -    | -    | -    | -    | -    | -    | -    | -    | -    | -    | - |
| 3000        | 2280       | 2349 | 2411 | 2641 | 2885 | 2923 | 3107 | 3167 | 3447 | 3695 | 3745 | 3912 | 4119 | -    | -    |      |   |



**Silkgrain Premium (42 mm insulated)**

**Linear medium design**

| Door Height | Door width |      |      |      |      |      |      |      |      |      |      |      |      |      |      |      |   |
|-------------|------------|------|------|------|------|------|------|------|------|------|------|------|------|------|------|------|---|
|             | 2000       | 2250 | 2375 | 2500 | 2750 | 3000 | 3250 | 3500 | 3750 | 4000 | 4250 | 4500 | 4750 | 5000 | 5250 | 5500 |   |
| 1900        | 1735       | 1799 | 1852 | 2089 | 2360 | 2532 | 2743 | 2749 | 2875 | 2995 | 3114 | 3225 | 3337 | 3463 | 3597 |      |   |
| 2000        | 1805       | 1862 | 1910 | 2170 | 2436 | 2608 | 2830 | 2840 | 2957 | 3114 | 3233 | 3340 | 3434 | 3563 | 3701 |      |   |
| 2080        | 1868       | 1911 | 1965 | 2229 | 2501 | 2679 | 2908 | 2930 | 3035 | 3207 | 3337 | 3451 | 3525 | 3659 | 3801 |      |   |
| 2125        | 1868       | 1911 | 1965 | 2229 | 2501 | 2679 | 2908 | 2930 | 3035 | 3207 | 3337 | 3451 | 3525 | 3659 | 3801 |      |   |
| 2205        | 1934       | 1981 | 2014 | 2294 | 2575 | 2760 | 2992 | 3013 | 3118 | 3300 | 3463 | 3550 | 3639 | 3777 | 3923 |      |   |
| 2250        | 1934       | 1981 | 2014 | 2294 | 2575 | 2760 | 2992 | 3013 | 3118 | 3300 | 3463 | 3550 | 3639 | 3777 | 3923 |      |   |
| 2375        | 1997       | 2052 | 2091 | 2370 | 2645 | 2816 | 3057 | 3101 | 3195 | 3399 | 3581 | 3683 | 3828 | 3976 | 4128 |      |   |
| 2500        | 2062       | 2115 | 2165 | 2476 | 2758 | 2929 | 3148 | 3181 | 3277 | 3495 | 3649 | 3811 | 4015 | 4177 | -    |      |   |
| 2600        | -          | -    | -    | -    | -    | -    | -    | -    | -    | -    | -    | -    | -    | -    | -    | -    | - |
| 2750        | 2404       | 2476 | 2545 | 2793 | 3061 | 3102 | 3303 | 3363 | 3835 | 4059 | 4196 | 4392 | -    | -    | -    |      |   |
| 2850        | -          | -    | -    | -    | -    | -    | -    | -    | -    | -    | -    | -    | -    | -    | -    | -    | - |
| 3000        | 2607       | 2685 | 2760 | 3030 | 3319 | 3367 | 3586 | 3654 | 3990 | 4283 | -    | -    | -    | -    | -    | -    | - |

■ Supplied with tensions spring as standard. Optional torsion spring available at additional cost, please see page 67.

□ These doors are only available with torsion spring.

For further options please see page 67.

For intermediate heights, between designated heights in the table above please add £ 150 (for example, a required height of 2175 mm would be taken from the designated height 2205 mm). Sandgrain doors are only available in the following colours: Anthracite Grey (RAL 7016) and Traffic White (RAL 9016). Cost for Sandgrain coloured doors is £ 61 per m<sup>2</sup>. Other colours and RAL to choose are not possible.

For Linear Medium (Silkgrain) models, price available on request for door sizes 4750 mm to 5000 mm width and 2600 mm to 2850 mm height.

For Linear Medium (Silkgrain) models, price available on request for door sizes 5000 mm to 5500 mm width and 2600 mm to 2750 mm height.

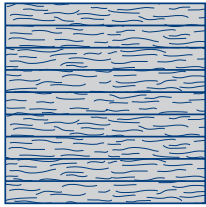

**Timber Effect / Titan (CH 703) Premium (42 mm insulated)**

**Linear medium design**

Door width

| Door Height | 2000 | 2250 | 2375 | 2500 | 2750 | 3000 | 3250 | 3500 | 3750 | 4000 | 4250 | 4500 | 4750 | 5000 | 5250 | 5500 |
|-------------|------|------|------|------|------|------|------|------|------|------|------|------|------|------|------|------|
| 1900        | 1909 | 1981 | 2040 | 2308 | 2614 | 2808 | 3047 | 3053 | 3195 | 3331 | 3465 | 3590 | 3717 | 3859 | 4011 |      |
| 2000        | 1982 | 2048 | 2101 | 2395 | 2695 | 2889 | 3140 | 3151 | 3285 | 3462 | 3595 | 3718 | 3823 | 3968 | 4124 |      |
| 2080        | 2052 | 2101 | 2162 | 2461 | 2769 | 2969 | 3228 | 3252 | 3372 | 3565 | 3713 | 3842 | 3925 | 4076 | 4237 |      |
| 2125        | 2052 | 2101 | 2162 | 2461 | 2769 | 2969 | 3228 | 3252 | 3372 | 3565 | 3713 | 3842 | 3925 | 4076 | 4237 |      |
| 2205        | 2126 | 2179 | 2214 | 2531 | 2848 | 3058 | 3319 | 3344 | 3462 | 3668 | 3852 | 3949 | 4051 | 4207 | 4372 |      |
| 2250        | 2126 | 2179 | 2214 | 2531 | 2848 | 3058 | 3319 | 3344 | 3462 | 3668 | 3852 | 3949 | 4051 | 4207 | 4372 |      |
| 2375        | 2194 | 2256 | 2301 | 2615 | 2926 | 3119 | 3391 | 3442 | 3547 | 3778 | 3984 | 4099 | 4263 | 4430 | 4601 |      |
| 2500        | 2267 | 2327 | 2382 | 2734 | 3052 | 3245 | 3493 | 3530 | 3639 | 3884 | 4059 | 4242 | 4473 | 4654 | 4837 |      |
| 2600        | 2637 | 2719 | 2796 | 3077 | 3380 | 3427 | 3652 | 3721 | 4254 | 4507 | 4662 | 4882 | 4998 | 5193 | 5401 |      |
| 2750        | 2648 | 2730 | 2807 | 3088 | 3391 | 3438 | 3663 | 3732 | 4265 | 4518 | 4673 | 4893 | 5009 | 5204 | 5412 |      |
| 2850        | 2860 | 2948 | 3033 | 3338 | 3664 | 3718 | 3966 | 4044 | 4422 | 4752 | 4821 | 5044 | 5320 | -    | -    |      |
| 3000        | 2873 | 2961 | 3046 | 3351 | 3677 | 3731 | 3979 | 4057 | 4435 | 4765 | 4834 | 5057 | 5333 | -    | -    |      |

Supplied with tension spring as standard. Optional torsion spring available at additional cost, please see page 67.

These doors are only available with torsion spring.

For further options please see page 67.

For intermediate heights, between designated heights in the table above please add £ 150 (for example, a required height of 2175 mm would be taken from the designated height 2205 mm).

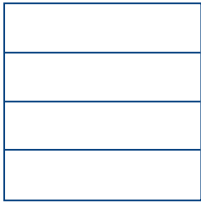

**Woodgrain Premium (42 mm insulated)**

**Linear large design**

| Door Height | Door width |      |      |      |      |      |      |      |      |      |      |      |      |      |      |      |
|-------------|------------|------|------|------|------|------|------|------|------|------|------|------|------|------|------|------|
|             | 2000       | 2250 | 2375 | 2500 | 2750 | 3000 | 3250 | 3500 | 3750 | 4000 | 4250 | 4500 | 4750 | 5000 | 5250 | 5500 |
| 1900        | 1811       | 1874 | 1930 | 2177 | 2457 | 2619 | 2847 | 2855 | 2984 | 3115 | 3238 | 3358 | 3477 | 3675 | 3815 |      |
| 2000        | 1877       | 1931 | 1982 | 2254 | 2530 | 2696 | 2930 | 2945 | 3068 | 3237 | 3358 | 3478 | 3571 | 3773 | 3921 |      |
| 2080        | 1933       | 1982 | 2036 | 2317 | 2602 | 2770 | 3014 | 3038 | 3152 | 3333 | 3470 | 3596 | 3675 | 3878 | 4030 |      |
| 2125        | 1933       | 1982 | 2036 | 2317 | 2602 | 2770 | 3014 | 3038 | 3152 | 3333 | 3470 | 3596 | 3675 | 3878 | 4030 |      |
| 2205        | 1972       | 2023 | 2063 | 2341 | 2629 | 2846 | 3100 | 3129 | 3232 | 3431 | 3600 | 3692 | 3782 | 4000 | 4162 |      |
| 2250        | 1972       | 2023 | 2063 | 2341 | 2629 | 2846 | 3100 | 3129 | 3232 | 3431 | 3600 | 3692 | 3782 | 4000 | 4162 |      |
| 2375        | 2016       | 2065 | 2094 | 2390 | 2681 | 2911 | 3163 | 3213 | 3317 | 3526 | 3720 | 3834 | 3990 | 4211 | 4378 |      |
| 2500        | 2045       | 2103 | 2148 | 2457 | 2733 | 3028 | 3266 | 3297 | 3398 | 3631 | 3797 | 3969 | 4189 | 4425 | 4597 |      |
| 2600        | 2104       | 2168 | 2225 | 2577 | 2849 | 3144 | 3336 | 3396 | 3479 | 3738 | 3985 | 4162 | 4392 | 4645 | 4823 |      |
| 2750        | 2319       | 2391 | 2462 | 2878 | 3182 | 3258 | 3431 | 3483 | 3633 | 3903 | 4161 | 4352 | 4592 | 4852 | 5040 |      |
| 2850        | 2569       | 2635 | 2702 | 2996 | 3303 | 3363 | 3570 | 3633 | 3789 | 4068 | 4345 | 4544 | 4795 | 5068 | -    |      |
| 3000        | 2667       | 2753 | 2830 | 3118 | 3427 | 3479 | 3714 | 3781 | 3946 | 4241 | 4521 | 4729 | 4994 | -    | -    |      |

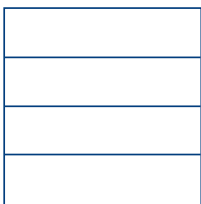

**Slategrain Premium (42 mm insulated)**

**Linear large design**

| Door Height | Door width |      |      |      |      |      |      |      |      |      |      |      |      |      |      |      |
|-------------|------------|------|------|------|------|------|------|------|------|------|------|------|------|------|------|------|
|             | 2000       | 2250 | 2375 | 2500 | 2750 | 3000 | 3250 | 3500 | 3750 | 4000 | 4250 | 4500 | 4750 | 5000 | 5250 | 5500 |
| 1900        | 1811       | 1874 | 1930 | 2177 | 2457 | 2619 | 2847 | 2855 | 2984 | 3115 | 3238 | 3358 | 3477 | 3675 | 3815 |      |
| 2000        | 1877       | 1931 | 1982 | 2254 | 2530 | 2696 | 2930 | 2945 | 3068 | 3237 | 3358 | 3478 | 3571 | 3773 | 3921 |      |
| 2080        | 1933       | 1982 | 2036 | 2317 | 2602 | 2770 | 3014 | 3038 | 3152 | 3333 | 3470 | 3596 | 3675 | 3878 | 4030 |      |
| 2125        | 1933       | 1982 | 2036 | 2317 | 2602 | 2770 | 3014 | 3038 | 3152 | 3333 | 3470 | 3596 | 3675 | 3878 | 4030 |      |
| 2205        | 1972       | 2023 | 2063 | 2341 | 2629 | 2846 | 3100 | 3129 | 3232 | 3431 | 3600 | 3692 | 3782 | 4000 | 4162 |      |
| 2250        | 1972       | 2023 | 2063 | 2341 | 2629 | 2846 | 3100 | 3129 | 3232 | 3431 | 3600 | 3692 | 3782 | 4000 | 4162 |      |
| 2375        | 2016       | 2065 | 2094 | 2390 | 2681 | 2911 | 3163 | 3213 | 3317 | 3526 | 3720 | 3834 | 3990 | 4211 | 4378 |      |
| 2500        | 2045       | 2103 | 2148 | 2457 | 2733 | 3028 | 3266 | 3297 | 3398 | 3631 | 3797 | 3969 | 4189 | 4425 | 4597 |      |
| 2600        | 2104       | 2168 | 2225 | 2577 | 2849 | 3144 | 3336 | 3396 | 3479 | 3738 | 3985 | 4162 | 4392 | 4645 | 4823 |      |
| 2750        | 2319       | 2391 | 2462 | 2878 | 3182 | 3258 | 3431 | 3483 | 3633 | 3903 | 4161 | 4352 | 4592 | 4852 | 5040 |      |
| 2850        | 2569       | 2635 | 2702 | 2996 | 3303 | 3363 | 3570 | 3633 | 3789 | 4068 | 4345 | 4544 | 4795 | 5068 | -    |      |
| 3000        | 2667       | 2753 | 2830 | 3118 | 3427 | 3479 | 3714 | 3781 | 3946 | 4241 | 4521 | 4729 | 4994 | -    | -    |      |

Supplied with tension spring as standard. Optional torsion spring available at additional cost, please see page 67.

These doors are only available with torsion spring.

For further options please see page 67.

For intermediate heights, between designated heights in the table above please add £ 150 (for example, a required height of 2175 mm would be taken from the designated height 2205 mm).



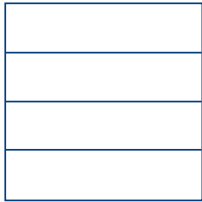

**Sandgrain Premium (42 mm insulated)**

**Linear large design**

| Door Height | Door width |      |      |      |      |      |      |      |      |      |      |      |      |      |      |      |
|-------------|------------|------|------|------|------|------|------|------|------|------|------|------|------|------|------|------|
|             | 2000       | 2250 | 2375 | 2500 | 2750 | 3000 | 3250 | 3500 | 3750 | 4000 | 4250 | 4500 | 4750 | 5000 | 5250 | 5500 |
| 1900        | 1923       | 1934 | 1944 | 2140 | 2346 | 2540 | 2611 | 2648 | 2665 | 2831 | 2917 | 2989 | 3014 | 3067 | 3127 |      |
| 2000        | 1955       | 1957 | 1971 | 2197 | 2429 | 2628 | 2690 | 2738 | 2868 | 2940 | 3013 | 3175 | 3202 | 3258 | 3320 |      |
| 2080        | 1978       | 1982 | 1987 | 2247 | 2470 | 2674 | 2744 | 2757 | 2925 | 3022 | 3114 | 3226 | 3281 | 3338 | 3404 |      |
| 2125        | 1978       | 1982 | 1987 | 2247 | 2470 | 2674 | 2744 | 2757 | 2925 | 3022 | 3114 | 3226 | 3281 | 3338 | 3404 |      |
| 2205        | 2018       | 2034 | 2063 | 2362 | 2597 | 2725 | 2786 | 2828 | 3011 | 3094 | 3202 | 3304 | 3354 | 3414 | 3480 |      |
| 2250        | 2018       | 2034 | 2063 | 2362 | 2597 | 2725 | 2786 | 2828 | 3011 | 3094 | 3202 | 3304 | 3354 | 3414 | 3480 |      |
| 2375        | 2033       | 2050 | 2106 | 2414 | 2620 | 2777 | 2844 | 2925 | 3090 | 3173 | 3291 | 3426 | 3528 | 3595 | 3665 |      |
| 2500        | 2046       | 2089 | 2155 | 2469 | 2658 | 2818 | 2888 | 2972 | 3151 | 3247 | 3385 | 3512 | 3706 | 3772 | 3847 |      |
| 2600        | 2191       | 2239 | 2321 | 2714 | 2874 | 2960 | 3017 | 3129 | 3349 | 3471 | 3695 | 3836 | 4050 | 4123 | 4208 |      |
| 2750        | 2202       | 2250 | 2332 | 2725 | 2885 | 2971 | 3028 | 3140 | 3360 | 3482 | 3706 | 3847 | 4061 | 4134 | 4219 |      |
| 2850        | 2639       | 2695 | 2727 | 2998 | 3153 | 3235 | 3296 | 3395 | 3631 | 3770 | 4014 | 4166 | 4402 | -    | -    |      |
| 3000        | 2652       | 2708 | 2740 | 3011 | 3166 | 3248 | 3309 | 3408 | 3644 | 3783 | 4027 | 4179 | 4415 | -    | -    |      |

 Supplied with tension spring as standard. Optional torsion spring available at additional cost, please see page 67.

 These doors are only available with torsion spring.

For further options please see page 67.

For intermediate heights, between designated heights in the table above please add £ 150 (for example, a required height of 2175 mm would be taken from the designated height 2205 mm).

Heights between 2505 mm - 2570 mm and 2755 mm - 2870 mm are not available in Sandgrain. Sandgrain doors are only available in the following colours: Anthracite Grey (RAL 7016) and Traffic White (RAL 9016). Cost for Sandgrain coloured doors is £ 61 per m<sup>2</sup>. Other colours and RAL to choose are not possible.

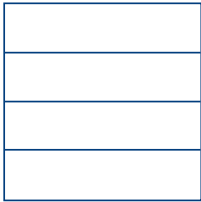

**Silkgrain Premium (42 mm insulated)**

**Linear large design**

| Door Height | Door width |      |      |      |      |      |      |      |      |      |      |      |      |      |      |      |
|-------------|------------|------|------|------|------|------|------|------|------|------|------|------|------|------|------|------|
|             | 2000       | 2250 | 2375 | 2500 | 2750 | 3000 | 3250 | 3500 | 3750 | 4000 | 4250 | 4500 | 4750 | 5000 | 5250 | 5500 |
| 1900        | 2134       | 2147 | 2158 | 2384 | 2616 | 2838 | 2918 | 2959 | 2979 | 3168 | 3266 | 3346 | 3376 | 3437 | 3502 |      |
| 2000        | 2166       | 2170 | 2185 | 2445 | 2708 | 2933 | 3003 | 3058 | 3206 | 3288 | 3372 | 3555 | 3586 | 3652 | 3721 |      |
| 2080        | 2190       | 2195 | 2201 | 2498 | 2753 | 2980 | 3061 | 3080 | 3267 | 3379 | 3486 | 3608 | 3671 | 3741 | 3816 |      |
| 2125        | 2190       | 2195 | 2201 | 2498 | 2753 | 2980 | 3061 | 3080 | 3267 | 3379 | 3486 | 3608 | 3671 | 3741 | 3816 |      |
| 2205        | 2233       | 2253 | 2284 | 2625 | 2895 | 3038 | 3107 | 3155 | 3365 | 3456 | 3582 | 3696 | 3757 | 3828 | 3901 |      |
| 2250        | 2233       | 2253 | 2284 | 2625 | 2895 | 3038 | 3107 | 3155 | 3365 | 3456 | 3582 | 3696 | 3757 | 3828 | 3901 |      |
| 2375        | 2249       | 2272 | 2331 | 2684 | 2919 | 3093 | 3173 | 3262 | 3455 | 3548 | 3684 | 3835 | 3958 | 4029 | 4109 |      |
| 2500        | 2263       | 2310 | 2389 | 2746 | 2963 | 3139 | 3220 | 3318 | 3521 | 3630 | 3789 | 3933 | 4151 | 4225 | -    |      |
| 2600        | 2426       | 2482 | 2572 | 3021 | 3199 | 3299 | 3365 | 3491 | 3740 | 3882 | 4140 | 4297 | -    | -    | -    |      |
| 2750        | 2437       | 2493 | 2583 | 3032 | 3210 | 3310 | 3376 | 3502 | 3751 | 3893 | 4151 | 4308 | -    | -    | -    |      |
| 2850        | 2930       | 2992 | 3032 | 3338 | 3517 | 3610 | 3679 | 3793 | 4063 | 4219 | 4495 | -    | -    | -    | -    |      |
| 3000        | 2943       | 3005 | 3045 | 3351 | 3530 | 3623 | 3692 | 3806 | 4076 | 4232 | 4508 | -    | -    | -    | -    |      |

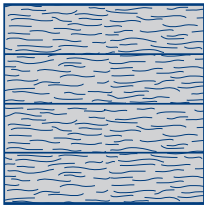

**Timber Effect / Titan (CH 703) Premium (42 mm insulated)**

**Linear large design**

| Door Height | Door width |      |      |      |      |      |      |      |      |      |      |      |      |      |      |      |
|-------------|------------|------|------|------|------|------|------|------|------|------|------|------|------|------|------|------|
|             | 2000       | 2250 | 2375 | 2500 | 2750 | 3000 | 3250 | 3500 | 3750 | 4000 | 4250 | 4500 | 4750 | 5000 | 5250 | 5500 |
| 1900        | 2323       | 2337 | 2350 | 2600 | 2857 | 3103 | 3192 | 3238 | 3260 | 3469 | 3578 | 3667 | 3700 | 3768 | 3839 |      |
| 2000        | 2356       | 2361 | 2378 | 2666 | 2957 | 3207 | 3285 | 3346 | 3509 | 3601 | 3693 | 3897 | 3930 | 4004 | 4081 |      |
| 2080        | 2381       | 2387 | 2394 | 2722 | 3006 | 3258 | 3347 | 3368 | 3575 | 3700 | 3818 | 3954 | 4023 | 4101 | 4184 |      |
| 2125        | 2381       | 2387 | 2394 | 2722 | 3006 | 3258 | 3347 | 3368 | 3575 | 3700 | 3818 | 3954 | 4023 | 4101 | 4184 |      |
| 2205        | 2427       | 2450 | 2483 | 2862 | 3161 | 3320 | 3396 | 3450 | 3683 | 3783 | 3923 | 4050 | 4117 | 4195 | 4277 |      |
| 2250        | 2427       | 2450 | 2483 | 2862 | 3161 | 3320 | 3396 | 3450 | 3683 | 3783 | 3923 | 4050 | 4117 | 4195 | 4277 |      |
| 2375        | 2443       | 2469 | 2535 | 2925 | 3186 | 3379 | 3469 | 3567 | 3780 | 3884 | 4034 | 4203 | 4338 | 4417 | 4507 |      |
| 2500        | 2457       | 2510 | 2597 | 2993 | 3234 | 3429 | 3519 | 3628 | 3852 | 3974 | 4150 | 4310 | 4551 | 4634 | 4731 |      |
| 2600        | 2636       | 2699 | 2798 | 3296 | 3494 | 3604 | 3678 | 3817 | 4093 | 4250 | 4537 | 4711 | 4982 | 5074 | 5180 |      |
| 2750        | 2647       | 2710 | 2809 | 3307 | 3505 | 3615 | 3689 | 3828 | 4104 | 4261 | 4548 | 4722 | 4993 | 5085 | 5191 |      |
| 2850        | 3192       | 3261 | 3305 | 3645 | 3843 | 3946 | 4023 | 4149 | 4449 | 4622 | 4928 | 5124 | 5418 | -    | -    |      |
| 3000        | 3205       | 3274 | 3318 | 3658 | 3856 | 3959 | 4036 | 4162 | 4462 | 4635 | 4941 | 5137 | 5431 | -    | -    |      |

■ Supplied with tension spring as standard. Optional torsion spring available at additional cost, please see page 67.

□ These doors are only available with torsion spring.

For further options please see page 67.

For intermediate heights, between designated heights in the table above please add £ 150 (for example, a required height of 2175 mm would be taken from the designated height 2205 mm). Please note, heights between 2505 mm - 2570 mm and 2755 mm - 2870 mm are not available in Silkgrain, Timber Effect and Titan (CH 703) doors.

For Linear Medium (Silkgrain) models, price available on request for door sizes 4750 mm to 5000 mm width and 2600 mm to 2850 mm height.

For Linear Medium (Silkgrain) models, price available on request for door sizes 5000 mm to 5500 mm width and 2600 mm to 2750 mm height.

## Options for sectional doors

add

Special anchor set (required if you fix the door between brickwork and fasten the frame on the side).  
If using special anchor set 90 mm cover profiles will be required to cover fixing holes. Two anchor sets are required for doors over 2250mm high.

77

Please note: Frame legs for brown and any coloured doors come in white as standard, matching cover profiles are available. Silkgrain, Foil Coated Timber Effect and Titan Metallic (CH 703) are available ex-stock. Please however note Colours and RAL to choose must be ordered with the door and cannot be ordered as a spare part at a later time.

## Cover Profiles

| Door height   | White     |     |  |     | Standard Colour |     |  |     | RAL to choose |     |                       |     | Special RAL |     |           |     | Foil Coated Timber Effect / Titan (CH 703) |     |
|---|-----------|-----|--|-----|-----------------|-----|--|-----|---------------|-----|-----------------------|-----|-------------|-----|-----------|-----|--|-----|
|   | Woodgrain |     | Sandgrain/<br>Silkgrain/<br>Slategrain |     | Woodgrain       |     | Sandgrain/<br>Silkgrain/<br>Slategrain<br>(Smooth) |     | Woodgrain     |     | Silkgrain<br>(Smooth) |     | Woodgrain   |     | Silkgrain |     | 55   | 90  |
| 1875  | 83        | 116 | 87                                     | 127 | 97              | 145 | 118  | 152 | 139           | 205 | 145                   | 222 | 154         | 242 | 161       | 258 | 130  | 162 |
| 2000  | 88        | 124 | 94                                     | 135 | 102             | 155 | 126  | 161 | 149           | 218 | 155                   | 235 | 163         | 258 | 172       | 275 | 137  | 172 |
| 2125  | 95        | 132 | 100                                    | 143 | 108             | 164 | 135  | 172 | 158           | 232 | 164                   | 251 | 173         | 273 | 182       | 291 | 145  | 183 |
| 2250  | 100       | 139 | 105                                    | 153 | 115             | 174 | 142  | 182 | 167           | 246 | 174                   | 265 | 185         | 289 | 193       | 309 | 155  | 194 |
| 2375  | 105       | 146 | 110                                    | 160 | 122             | 185 | 151  | 192 | 176           | 260 | 185                   | 281 | 193         | 305 | 204       | 325 | 163  | 205 |
| 2500  | 110       | 155 | 116                                    | 169 | 127             | 193 | 158  | 201 | 186           | 273 | 193                   | 295 | 204         | 321 | 215       | 343 | 171  | 215 |
| For door heights not specified above, use formula: door height x price below (i.e. door height 2600 for "White Woodgrain 55": 2.6 x 44 = £ 114,4) |           |     |  |     |                 |     |  |     |               |     |                       |     |             |     |           |     |  |     |
|   | 44        | 61  | 47                                     | 66  | 51              | 76  | 62   | 79  | 73            | 108 | 76                    | 117 | 82          | 128 | 86        | 138 | 68   | 86  |

|  |     |
|--|-----|
| Purpose-made width cut-down service (check for size limitations).  | 110 |
| Purpose-made height cut-down service (check for size limitations).   | 150 |
| Classic black handle set and lock for on-site installation   | 88  |
| White finish cast aluminium handle set and lock for on-site installation   | 241 |
| Brushed stainless steel finish cast aluminium handle set and lock for on-site installation   | 241 |
| Factory cut hole for handle and lock available with a 2 week increase in lead-time (complete with classic black handle as standard) <sup>1</sup> | 134 |
| Standard headroom torsion spring for sectional door less than 4000 mm wide <sup>2</sup>  | 107 |
| Low headroom tracks arrangement for torsion spring door over 4000 mm wide (when purchased with door) <sup>2</sup>                                | 174 |

<sup>1</sup> Please note: Only available for stock doors (highlighted in bold) on pages 50 - 59.

<sup>2</sup> Excluding Silkgrain. For Silkgrain surface finish, torsion spring gear can only be supplied on doors over 3050 mm wide.

## ThermoFrame set

### ThermoFrame set 4

|           |               |                           |                |         |     |
|-----------|---------------|---------------------------|----------------|---------|-----|
| RM height | up to 3000 mm | 3x plastic angle profiles | Length 3210 mm | per set | 434 |
| LZ width  | up to 3210 mm |                           |                |         |     |

### ThermoFrame set 5

|           |                            |                           |                |         |     |
|-----------|----------------------------|---------------------------|----------------|---------|-----|
| RM height | up to 3000 mm              | 2x plastic angle profiles | Length 3210 mm | per set | 434 |
| LZ width  | from 3210 mm up to 6000 mm | 1x plastic angle profile  | Length 6000 mm |         |     |

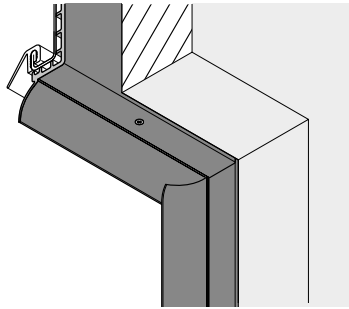

Set consists of

- 3x Plastic angle profiles black 84 x 22.5 mm with lip seal

**Note on set 4 and 5 (frame covering not possible):**

- A single-skinned fascia panel is fitted. Required headroom corresponds with track application Z, N and L.
- Please also note the supplements and limitations in the technical manual!

## Options for purpose-made sectional doors

|   |                    |     |
|---|--------------------|-----|
| Standard colour finish for purpose made sectional doors (i.e. 2000 mm x 2125 mm is an area of 4.25 m <sup>2</sup> ) | per m <sup>2</sup> | 58  |
| RAL to choose or CH 703 colour finish for purpose made sectional doors  | per m <sup>2</sup> | 93  |
| Special colour finish for purpose made sectional doors  | per m <sup>2</sup> | 183 |
| Top fascia for sectional doors (95 mm). Woodgrain surface texture (Traffic White RAL 9016)                          | per m              | 44  |
| Top fascia for sectional doors (95 mm). Sandgrain surface texture (Traffic White RAL 9016)                          | per m              | 49  |
| Top fascia for sectional doors (95 mm). Silkgrain surface texture (Traffic White RAL 9016)                          | per m              | 49  |
| Top fascia for sectional doors (95 mm). Timber Effect surface texture (Timber Effect and CH 703)                    | per m              | 70  |
| Top fascia for sectional doors (95 mm). Standard colour finish  | per m <sup>2</sup> | 58  |
| Top fascia for sectional doors (95 mm). RAL to choose or CH 703   | per m <sup>2</sup> | 95  |
| Top fascia for sectional doors (95 mm). Special RAL colours   | per m <sup>2</sup> | 183 |

Sectional doors up to 4000 mm wide and/ or 2500 mm high (excluding Silkgrain surface finish) and  
 Sectional doors up to 3048 mm wide and/ or 2500 mm high (with Silkgrain surface finish):

These doors come with tension spring fitting. With doors from the Premium range the tension springs can be replaced by torsion springs as an option. Tension springs are suitable for low headroom installations. For a low headroom installation with torsion springs please order low headroom track set separately (changing to a low headroom option is not available as a retrofit).

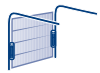
 **Sectional garage door  
 with tension spring fitting**

Minimum garage dimensions for manually operated doors

|   |                             |
|---|-----------------------------|
| Headroom:   | 100 mm                      |
| Sideroom:   | 90 mm (each side)           |
| Depth into garage:                                      | garage door height + 510 mm |
| Clear passage height<br>for manually operated<br>doors: | garage door height – 80 mm  |

Minimum garage dimensions for doors with GaraMatic operator

|                    |   |
|--------------------|---|
| Headroom           | 115 mm  |
| Sideroom:          | 90 mm (each side)   |
| Depth into garage: | for doors up to 2125 mm high: 3200 mm<br>for doors up to 2500 mm high: 3450 mm<br>for doors up to 3000 mm high: 4125 mm |

|   |                            |
|---|----------------------------|
| Clear passage height<br>for doors with<br>GaraMatic operator: | garage door height – 30 mm |
|---|----------------------------|

|   |        |
|---|--------|
| Minimum ceiling height:                       | 115 mm |
| Minimum ceiling height<br>(with ThermoFrame): | 145 mm |

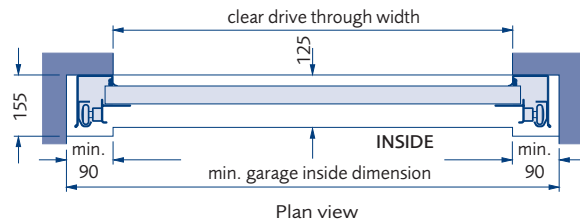
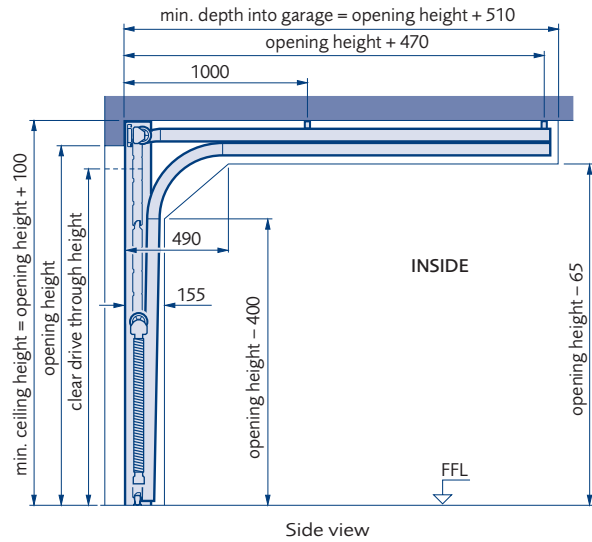

**Sectional doors with torsion spring fitting wider than 4000 mm wide (excluding Silkgrain surface finish) and Sectional doors wider than 3048 mm wide (with Silkgrain surface finish):**

These doors come with torsion springs as standard. For a low headroom installation with torsion springs please order low headroom track pack (changing to a low headroom option is not available as a retrofit).



**Sectional garage door with torsion spring fitting**

Minimum garage dimensions for manually operated doors

|   |                             |
|---|-----------------------------|
| Headroom:   | 210 mm                      |
| Sideroom:   | 90 mm (each side)           |
| Depth into garage:                                | garage door height + 510 mm |
| Clear passage height for manually operated doors: | garage door height – 50 mm  |

Minimum garage dimensions for doors with GaraMatic operator

|                    |   |
|--------------------|---|
| Headroom:          | 210 mm  |
| Sideroom:          | 90 mm (each side)   |
| Depth into garage: | for doors up to 2125 mm high: 3200 mm<br>for doors up to 2500 mm high: 3450 mm<br>for doors up to 3000 mm high: 4125 mm |

Clear passage height for doors with GaraMatic operator: full garage door height

|  |        |
|--|--------|
| Minimum ceiling height:                    | 210 mm |
| Minimum ceiling height (with ThermoFrame): | 255 mm |

Excludes Silkgrain surface finish.  
Torsion spring available for doors over 3000 mm x 2250 mm

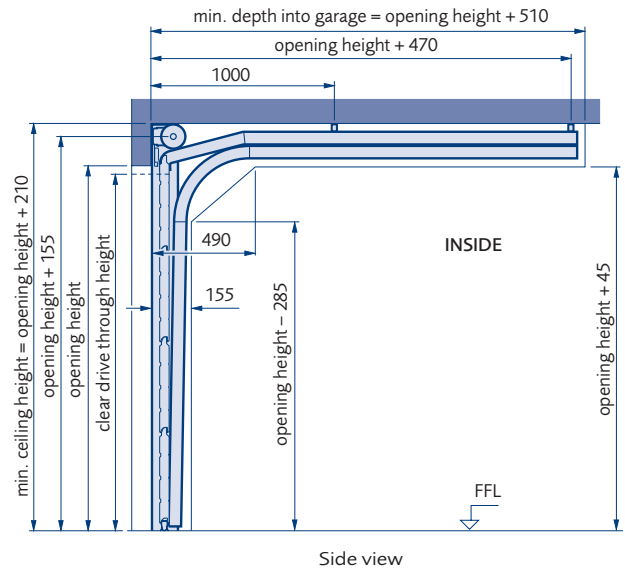

Side view

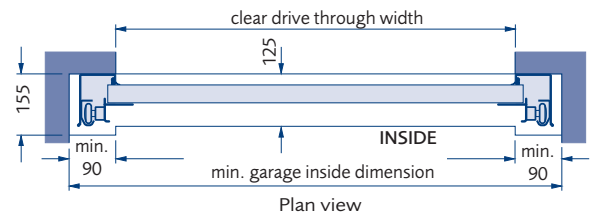

Plan view

Sectional doors with low-headroom torsion spring fitting wider than 4000 mm wide (excluding Silkgrain surface finish) and Sectional doors wider than 3048 mm wide (with Silkgrain surface finish):

These doors come with torsion springs as standard. For a low headroom installation with torsion springs please order low headroom track pack (changing to a low headroom option is not available as a retrofit).

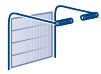

**Sectional garage door  
with low headroom torsion spring fitting**

Minimum garage dimensions for manually operated doors

|   |                             |
|---|-----------------------------|
| Headroom:   | 100 mm                      |
| Sideroom:   | 90 mm (each side)           |
| Depth into garage:                                | garage door height + 510 mm |
| Clear passage height for manually operated doors: | garage door height – 100 mm |

Minimum garage dimensions for doors with GaraMatic operator

|   |  |
|---|--|
| Headroom:   | 115 mm   |
| Sideroom:   | 90 mm (each side)  |
| Depth into garage:                                      | for doors up to 2125 mm high: 3200 mm<br>for doors up to 3000 mm high: 4125 mm   |
| Clear passage height for doors with GaraMatic operator: | for doors up to 3000 mm wide:<br>garage door height – 30 mm<br>for doors wider than 3000 mm:<br>garage door height – 80 mm |

Minimum ceiling height: 115 mm

Minimum ceiling height (with ThermoFrame): 145 mm

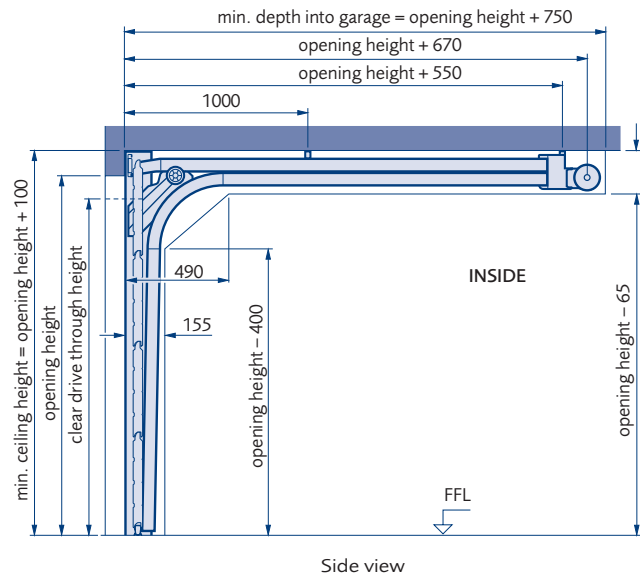

Side view

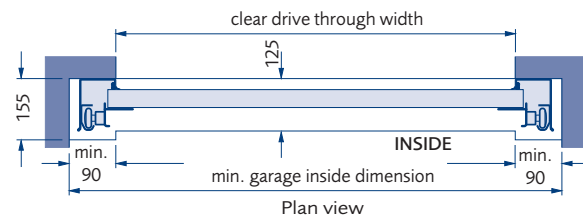

Plan view

# Automation and Accessories

## Operators

GaraMatic operators are an ideal match for all current Garador up & over and sectional garage doors. They are a tried and tested hardware combination, designed for use with Garador up & over or sectional garage doors, and prepared for easy installation. They feature energy efficient LED light, a power saving mode and a mechanical lock, built into the operator boom, to prevent forced lifting of the door.

## What's Included

All GaraMatic operators come as a complete set, including operator head, boom and two 4-button hand transmitters.



### BlueSecur App

The Garador BlueSecur app allows you to control your Series 4 GaraMatic operator from your android or ios smartphone. It allows you to operate the open/close, partial opening and integral light functions.



Both the GaraMatic 10 and GaraMatic 20 are supplied complete with an integrated bluetooth receiver, for control via Garador's BlueSecur smartphone app for android and ios devices. One free user key is included. Others available via in-app purchase. Please refer to Garador BlueSecur for pricing. The bluetooth receiver can be switched on and off. An optional bluetooth receiver is available as an add-on for the GaraMatic 9.



### BS EN 13241 Compliant

The combination of Garador garage doors with GaraMatic operators complies with the latest European safety standards.





## Operators





| Operators   | GaraMatic 9   | GaraMatic 10  | GaraMatic 20   |
|---|---|---|--|
|   |    |   |   |
|   | <p><b>Peak forces</b><br/>750 N</p> <ul style="list-style-type: none"> <li>• Simple to operate</li> <li>• Soft start and stop</li> <li>• Max. opening speed 20 cm/s</li> <li>• Automatic safety reversal</li> <li>• Integral LED light with 10 LEDs</li> <li>• Low power consumption (less than 1 w in stand by mode)</li> <li>• Supplied with two 4-button hand transmitters (black end caps)</li> </ul> | <p><b>Peak forces</b><br/>800 N</p> <ul style="list-style-type: none"> <li>• Control element with 2x 7-segment display</li> <li>• Soft start and stop</li> <li>• Max. opening speed 25 cm/s</li> <li>• Automatic safety reversal</li> <li>• Adjustable integral LED light with 20 LEDs</li> <li>• Partial opening function</li> <li>• Self-closing timer option</li> <li>• Integrated bluetooth receiver</li> <li>• HCP interface to connect smarhome systems</li> <li>• Low power consumption (less than 1 w in stand by mode)</li> <li>• Supplied with two 4-button hand transmitters (chrome end caps)</li> <li>• BlueSecur App: One free user key included. Others available via in-app purchase</li> </ul> | <p><b>Peak forces</b><br/>1000 N</p> <ul style="list-style-type: none"> <li>• Control element with 2x 7-segment display</li> <li>• Soft start and stop</li> <li>• Max. opening speed 25 cm/s</li> <li>• Automatic safety reversal</li> <li>• Adjustable integral LED light with 30 LEDs</li> <li>• Partial opening function</li> <li>• Self-closing timer option</li> <li>• Integrated bluetooth receiver</li> <li>• HCP interface to connect smarhome systems</li> <li>• Low power consumption (less than 1 w in stand by mode)</li> <li>• Supplied with two 4-button hand transmitters (chrome end caps)</li> <li>• BlueSecur App: One free user key included. Others available via in-app purchase</li> </ul> |
| Canopy Doors <sup>1</sup>   | 640   | 805   | 859  |
| Standard short boom <sup>2</sup><br>Retractable and Sectional<br>Doors up to 2125 mm high | 524   | 647   | 719  |
| Medium boom <sup>2</sup>  | 559   | 682   | 754  |
| Long boom <sup>2</sup>  | 671   | 794   | 866  |





<sup>1</sup> Canopy door price includes bow arm system. GaraMatic 9 supplied with two 2-channel hand transmitters.





<sup>2</sup> For exact boom requirements see grid on page 77.











| Accessories   |  |  |  |  |
|---------------|---|---|--|---|
| Article       | Hand transmitter 5-channel (Bi-directional) in matt black                         | Hand transmitter 4-channel (Bi-directional) in matt black                         | Hand transmitter 4-channel (Bi-directional) in matt black (chrome caps)            | Hand transmitter 5-channel (Bi-directional) in white                                |
| Reference No. | 7471  | 7470  | 6809   | 6713  |
| Price £       | 86  | 66  | 73   | 86  |

| Accessories   |  |  |  |  |
|---------------|--|--|---|--|
| Article       | Hand transmitter 5-channel (Bi-directional) in black                               | Hand transmitter 1-channel (Bi-directional) in black                               | Hand transmitter 4-channel (Bi-directional) in black                                | Hand transmitter station in black  |
| Reference No. | 6714   | 6710   | 6779  | 6719   |
| Price £       | 86   | 73   | 73  | 13   |

| Accessories   |  |  |  |  |
|---------------|---|---|--|---|
| Article       | Hand transmitter station in white   | Hand transmitter sun visor/ wall holder   | 1-channel (Bi-directional) transmitter for car cigarette lighter                     | 2-channel (Bi-directional) transmitter for car cigarette lighter                      |
| Reference No. | 6720  | 6784  | 6782   | 6783  |
| Price £       | 13  | 12  | 66   | 66  |

|               |   |   |   |   |
|---------------|---|---|---|---|
| Accessories   |  |  |  |  |
| Article       | Hand transmitter<br>2-channel (Bi-directional)<br>Green                           | Robust 3-channel<br>(Bi-directional) hand<br>transmitter                          | IT3 B<br>Wired Wall Console   | FIT 2<br>Bi-directional wireless<br>wall console                                    |
| Reference No. | 6965  | 8880  | 8733  | 6718  |
| Price £       | 101   | 104   | 50  | 108   |

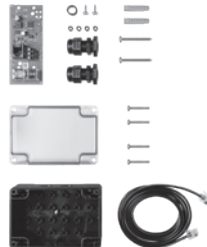
|               |   |   |   |   |
|---------------|---|---|---|---|
| Accessories   |  |  |  |  |
| Article       | IT1 B<br>Wired illuminated<br>push button   | Series 4<br>External Bluetooth<br>Antenna to increase signal<br>range             | IT1-1<br>Internal Push Button   | FCT 3 BS<br>Radio code switch   |
| Reference No. | 2875  | 8128  | 695   | 6717  |
| Price £       | 41  | 103   | 31  | 129   |

|               |   |   |  |  |
|---------------|---|---|--|--|
| Accessories   |  |  |              |                                       |
| Article       | FCT 10 Wireless Code<br>Switch (flip lid)<br>868 mHz bi-directional                 | Series 4<br>External Bluetooth<br>receiver<br>(GaraMatic 9 add-on)                  | Options relay for control<br>of garage light, warning<br>light or limit switch report<br>HOR-HCP | Series 4 Universal Adapter<br>Print for control of operator<br>light, partial open and venti-<br>lation position UAP-1-HCP |
| Reference No. | 6716  | 8129  | 8125   | 8421   |
| Price £       | 193   | 166   | 64   | 113  |

Accessories

|               |   |   |  |
|---------------|---|---|--|
|               |  |  |  |
| Article       | EL301N<br>External light beam<br>device   | Emergency Battery<br>Backup HNA 18-4<br>(for Series 4 operators)                  | EL101<br>Internal light beam device  |
| Reference No. | 2884  | 8126  | 6786   |
| Price £       | 155   | 255   | 95   |

## Additional options

|   |     |
|---|-----|
| De-latching kit Reference No. 705 for up & over doors, Garador single door range (437.195)<br>(required to maintain mechanical locking system retractable doors only)                     | 68  |
| De-latching kit Reference No. 2643 for up & over doors, Garador double door range (437.197)<br>(required to maintain mechanical locking system retractable doors only)                    | 112 |
| Emergency release Reference No. 704 for retractable up & over doors only<br>(required if door is electrically operated and has no other personal access)                                  | 45  |
| Emergency release Reference No. 703 for sectional door without handle and lock, or canopy up & over doors<br>(required if door is electrically operated and has no other personal access) | 63  |
| Emergency release Reference No. 702 for sectional door with handle and lock<br>(required if door is electrically operated and has no other personal access)                               | 64  |
| Lintel extension bracket Reference No. 709 for canopy doors<br>(required if door is fitted between brickwork under the lintel)  | 63  |

## Operator Specifications

### Boom for canopy door including canopy bow arm

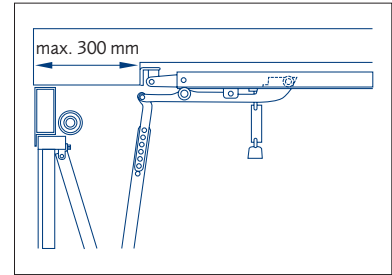
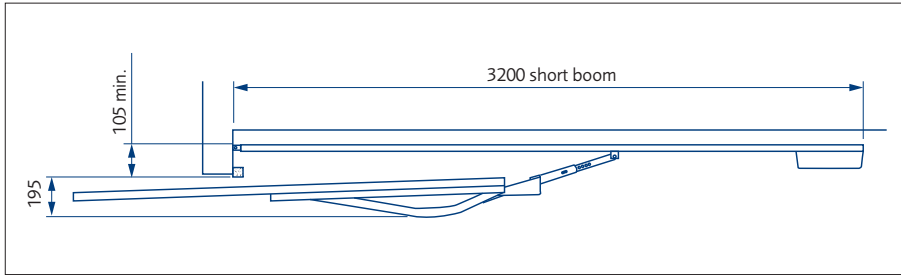

On horizontal doors the bow arm is to be fitted off centre.

Lintel extension bracket required for canopy doors fitted between the brickwork and under the lintel head.

### Boom for retractable door

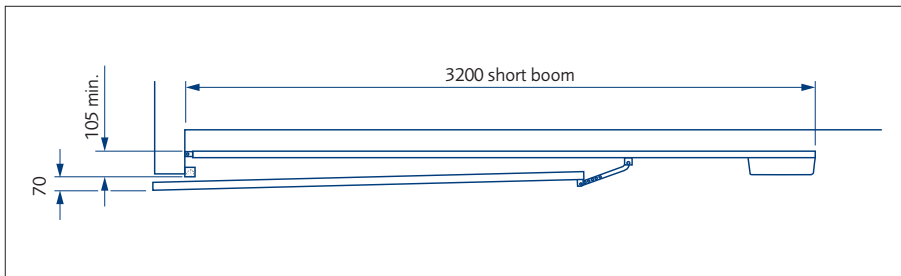

### Boom for sectional door

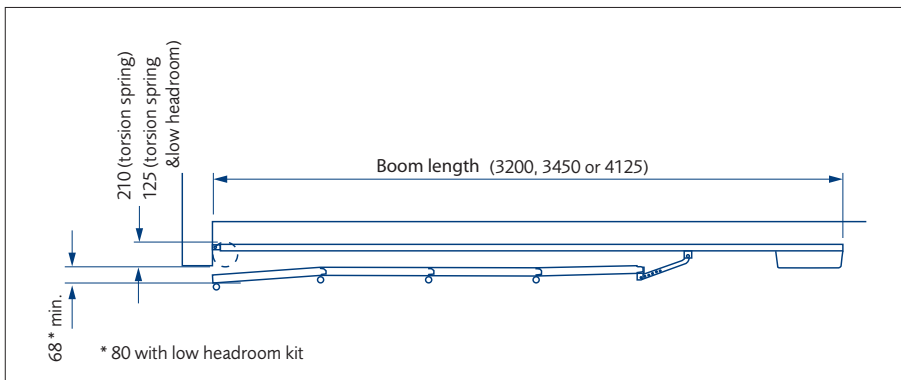

### Maximum Door Height to suit Operator Booms

|             | Torsion Spring | Tension and Low Headroom Spring | Travel distance |
|-------------|----------------|---------------------------------|-----------------|
| Short Boom  | 2250 mm        | 2125 mm                         | 2475 mm         |
| Medium Boom | 2500 mm        | 2375 mm                         | 2725 mm         |
| Long Boom   | 3000 mm        | 3000 mm                         | 3400 mm         |

# GaraRoll Roller Doors

## GaraRoll Insulated Roller Doors

Spring-compensated, automated roller garage door for domestic applications only. All doors are made to suit the opening with the actual door size relating to the structural opening width x height and the guides fitting on the reveals to maintain a full opening size. The GaraRoll is the only roller garage door to include the cover hood, which the curtain rolls into at the head of the garage door opening, as standard. The door is also supplied complete with a DuraBelt anti-scratch system, designed to provide a protective layer between each lath as they roll up when the door is open.

### Door curtain

77 mm rolled aluminium profile filled with 100 % CFC-free polyurethane rigid foam. Each lath is 15mm thick. Integrated windlocks fitted as standard.

### Surface

Colour finish with double layer coil coating quality paint system or foil-coated timber effect finish.

### Frame

Aluminium extrusion profile side guides with integrated plastic runners. Lintel and cover box made of steel. Colour of side guides and lintels supplied to match the door as standard. Except on foil-coated and deco paint timber effect doors where they are supplied in a solid brown paint finish. Cover box coated Grey White (RAL 9002).

### Counterbalance

Tension spring technology with lateral integral double tension springs and double cables encased within a transparent cover.

### Colours

Same colour inside and outside

- Light Ivory (RAL 1015)    - Moss Green (RAL 6005)    - Terra Brown (RAL 8028)    - White Aluminium (RAL 9006)
- Ruby Red (RAL 3003)    - Slate Grey (RAL 7015)    - Cream (RAL 9001)    - Grey Aluminium (RAL 9007)
- Purple Red (RAL 3004)    - Anthracite Grey (RAL 7016)    - Jet Black (RAL 9005)    - Traffic White (RAL 9016)
- Steel Blue (RAL 5011)    - Light Grey (RAL 7035)    - Chartwell Green

Deco paint doors available in Anthracite Metallic (Noir 2100 Sable), Golden Oak and Rosewood, with the same finish inside and out.

Foil-coated doors available in Golden Oak and Rosewood, with the inside of the lath in dark brown (foil coat not available on GaraRoll external roller garage door).

### Operator and Control

Garador operator and control included. 24 V DC gear drive, mains voltage 230-240 V AC, 0.5 kW, opening speed approx. 11 cm/s, integrated door security kit, operator always located on left (viewed from inside), plastic housing. Micro-processor control in separate plastic housing, automatic teaching of auto safety cut-out and travel limits, soft start and soft stop, light, impulse control, adjustable automatic timer (hold-open time 30 sec. after activation, additional photocell required). Included: 2 hand transmitters and integral receiver, connecting lead with CEE plug, control buttons in cover of the control unit, integrated 2-minute garage light in control housing, quick release (operated from inside). Please note, a wired optical sensor is included as a mandatory safety feature for all GaraRoll doors over 5000 mm wide.

### Windows

Window size approx. 120 x 40 mm, number of windows per door section depends on door width. Windows made of clear synthetic pane with black window frame on exterior, transparent frame on interior. Maximum of 10 window sections per door.

Window arrangement:

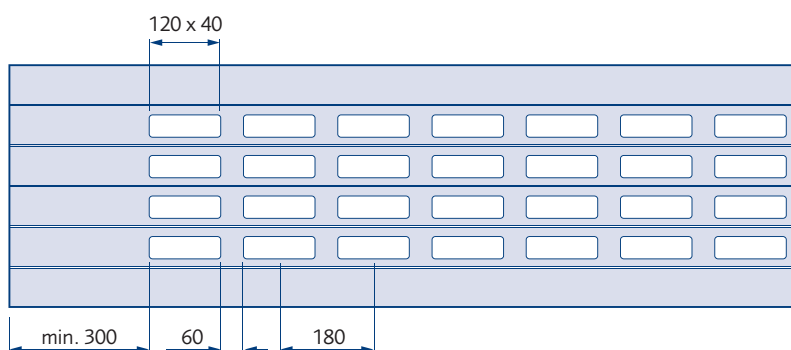

**Packaging**

GaraRoll doors are supplied in a palletted format shrink wrapped as a complete package.

**Stock availability**

All GaraRoll doors are made to order with no standard sizes. Lead-time for all doors is 3 to 4 weeks.

**Remember the GaraRoll door is measured as opening size and not as overall guide width.**

This not only makes it the same as all other Garador doors for sizing but also will probably reduce the price against other doors as most other door manufacturers calculate the price as over guide width thus making the actual door around 220 mm smaller!

Minimum product dimension is 1000 mm x 1600 mm.

Only the door prices highlighted are available with the external roller garage door fitting as an option.

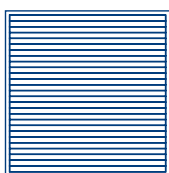

**Smooth paint finish**

Door width

| Door height | 1000 | 1250 | 1500 | 1750 | 1900 | 2000 | 2250 | 2500 | 2750 | 3000 | 3250 | 3500 | 3750 | 4000 | 4250 | 4500 | 4750 | 5000 | 5250 | 5500 | 5750 | 6000 |  |
|-------------|------|------|------|------|------|------|------|------|------|------|------|------|------|------|------|------|------|------|------|------|------|------|--|
| 1600        |      |      |      |      |      |      |      |      |      |      |      |      |      |      |      |      |      |      |      |      |      |      |  |
| 1875        |      | 2501 | 2501 | 2593 | 2593 | 2618 | 2756 | 2849 | 2943 | 2982 | 3219 | 3314 | 3706 | 3792 | 3957 | 4044 | 4138 | 4231 | 4628 | 4722 | 4815 | 4907 |  |
| 2000        |      | 2501 | 2501 | 2593 | 2593 | 2618 | 2756 | 2849 | 2943 | 2982 | 3219 | 3314 | 3706 | 3792 | 3957 | 4044 | 4138 | 4231 | 4628 | 4722 | 4815 | 4907 |  |
| 2125        |      | 2501 | 2501 | 2593 | 2593 | 2709 | 2875 | 2921 | 2999 | 3081 | 3327 | 3432 | 3858 | 3894 | 4122 | 4213 | 4307 | 4398 | 4795 | 4886 | 4979 | 5072 |  |
| 2250        |      | 2501 | 2501 | 2593 | 2593 | 2754 | 2962 | 3029 | 3093 | 3206 | 3490 | 3838 | 3983 | 4018 | 4235 | 4323 | 4415 | 4504 | 4903 | 4992 | 5080 | 5168 |  |
| 2375        |      | 2501 | 2501 | 2593 | 2593 | 2754 | 2962 | 3029 | 3093 | 3206 | 3490 | 3838 | 3983 | 4018 | 4235 | 4323 | 4415 | 4504 | 4903 | 4992 | 5080 | 5168 |  |
| 2500        |      | 2669 | 2669 | 2808 | 2808 | 2847 | 3009 | 3105 | 3218 | 3307 | 3602 | 3979 | 4053 | 4209 | 4375 | 4468 | 4560 | 4648 | 5045 | 5131 | 5222 | 5311 |  |
| 2625        |      | 2669 | 2669 | 2808 | 2808 | 2938 | 3094 | 3191 | 3308 | 3429 | 3965 | 4127 | 4268 | 4409 | 4517 | 4611 | 4699 | 4789 | -    | -    | -    | -    |  |
| 2675        |      | 2669 | 2669 | 2808 | 2808 | 2938 | 3094 | 3191 | 3308 | 3429 | 3965 | 4127 | 4268 | 4409 | 4517 | 4611 | 4699 | 4789 | -    | -    | -    | -    |  |
| 2750        |      | -    | -    | -    | 2938 | 3094 | 3191 | 3308 | 3429 | 3965 | 4127 | 4268 | 4409 | -    | -    | -    | -    | -    | -    | -    | -    | -    |  |
| 2875        |      | -    | -    | -    | 2977 | 3225 | 3307 | 3406 | 3489 | 4078 | 4216 | 4385 | 4472 | -    | -    | -    | -    | -    | -    | -    | -    | -    |  |
| 3000        |      | -    | -    | -    | 2977 | 3225 | 3307 | 3406 | 3489 | 4078 | 4216 | 4385 | 4472 | -    | -    | -    | -    | -    | -    | -    | -    | -    |  |
| 3100        |      | -    | -    | -    | 2977 | 3225 | 3307 | 3406 | 3489 | 4078 | 4216 | 4385 | 4472 | -    | -    | -    | -    | -    | -    | -    | -    | -    |  |

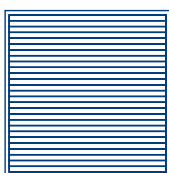

**Deco paint finish**

Door width

| Door height | 1000 | 1250 | 1500 | 1750 | 1900 | 2000 | 2250 | 2500 | 2750 | 3000 | 3250 | 3500 | 3750 | 4000 | 4250 | 4500 | 4750 | 5000 | 5250 | 5500 | 5750 | 6000 |  |
|-------------|------|------|------|------|------|------|------|------|------|------|------|------|------|------|------|------|------|------|------|------|------|------|--|
| 1600        |      |      |      |      |      |      |      |      |      |      |      |      |      |      |      |      |      |      |      |      |      |      |  |
| 1875        |      | 2596 | 2616 | 2727 | 2597 | 2770 | 2928 | 3040 | 3153 | 3211 | 3467 | 3581 | 3992 | 4097 | 4282 | 4388 | 4500 | 4613 | 5029 | 5141 | 5254 | 5365 |  |
| 2000        |      | 2603 | 2623 | 2735 | 2748 | 2780 | 3059 | 3124 | 3223 | 3325 | 3591 | 3716 | 4162 | 4218 | 4466 | 4578 | 4692 | 4804 | 5221 | 5332 | 5446 | 5558 |  |
| 2125        |      | 2609 | 2630 | 2740 | 2756 | 2926 | 3156 | 3244 | 3329 | 3464 | 3769 | 4139 | 4305 | 4361 | 4600 | 4710 | 4823 | 4934 | 5353 | 5465 | 5574 | 5683 |  |
| 2250        |      | 2614 | 2638 | 2752 | 2766 | 2936 | 3167 | 3256 | 3342 | 3478 | 3785 | 4155 | 4323 | 4380 | 4620 | 4731 | 4846 | 4958 | 5379 | 5490 | 5602 | 5712 |  |
| 2375        |      | 2788 | 2812 | 2976 | 2990 | 3037 | 3224 | 3344 | 3480 | 3593 | 3913 | 4313 | 4411 | 4590 | 4781 | 4898 | 5013 | 5125 | 5546 | 5656 | 5771 | 5883 |  |
| 2500        |      | 2795 | 2819 | 2984 | 2999 | 3138 | 3319 | 3442 | 3583 | 3730 | 4290 | 4478 | 4643 | 4810 | 4943 | 5062 | 5175 | 5290 | -    | -    | -    | -    |  |
| 2625        |      | 2797 | 2822 | 2988 | 3002 | 3142 | 3324 | 3447 | 3583 | 3735 | 4297 | 4484 | 4651 | 4817 | 4951 | 5070 | 5184 | 5299 | -    | -    | -    | -    |  |
| 2675        |      | -    | -    | -    | 3148 | 3330 | 3454 | 3597 | 3743 | 4306 | 4495 | 4661 | 4829 | -    | -    | -    | -    | -    | -    | -    | -    | -    |  |
| 2750        |      | -    | -    | -    | 3196 | 3472 | 3581 | 3708 | 3819 | 4434 | 4600 | 4796 | 4910 | -    | -    | -    | -    | -    | -    | -    | -    | -    |  |
| 2875        |      | -    | -    | -    | 3206 | 3483 | 3593 | 3721 | 3832 | 4450 | 4617 | 4814 | 4929 | -    | -    | -    | -    | -    | -    | -    | -    | -    |  |
| 3000        |      | -    | -    | -    | 3214 | 3492 | 3602 | 3732 | 3844 | 4463 | 4631 | 4671 | 4944 | -    | -    | -    | -    | -    | -    | -    | -    | -    |  |
| 3100        |      | -    | -    | -    | 3214 | 3492 | 3602 | 3732 | 3844 | 4463 | 4631 | 4671 | 4944 | -    | -    | -    | -    | -    | -    | -    | -    | -    |  |

Deco paint only available in Golden Oak, Anthracite Metallic (Noir 2100 Sable) or Rosewood finish.

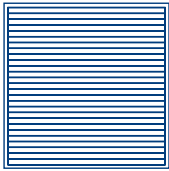

## Timber effect finish

| Door height | Door width |      |      |      |      |      |      |      |      |      |      |      |      |      |      |      |      |      |      |      |      |      |  |
|-------------|------------|------|------|------|------|------|------|------|------|------|------|------|------|------|------|------|------|------|------|------|------|------|--|
|             | 1000       | 1250 | 1500 | 1750 | 1900 | 2000 | 2250 | 2500 | 2750 | 3000 | 3250 | 3500 | 3750 | 4000 | 4250 | 4500 | 4750 | 5000 | 5250 | 5500 | 5750 | 6000 |  |
| 1600        |            |      |      |      |      |      |      |      |      |      |      |      |      |      |      |      |      |      |      |      |      |      |  |
| 1875        | 2665       | 2698 | 2823 | 2842 | 2881 | 3051 | 3176 | 3303 | 3376 | 3645 | 3773 | 4198 | 4317 | 4515 | 4635 | 4761 | 4887 | 5317 | 5444 | 5570 | 5695 |      |  |
| 2000        | 2676       | 2711 | 2838 | 2859 | 2897 | 3071 | 3199 | 3328 | 3402 | 3673 | 3804 | 4231 | 4231 | 4552 | 4674 | 4802 | 4931 | 5363 | 5491 | 5620 | 5747 |      |  |
| 2125        | 2687       | 2724 | 2853 | 2875 | 3007 | 3210 | 3293 | 3408 | 3527 | 3810 | 3952 | 4415 | 4415 | 4754 | 4882 | 5013 | 5141 | 5575 | 5703 | 5834 | 5964 |      |  |
| 2250        | 2698       | 2737 | 2869 | 2892 | 3069 | 3316 | 3422 | 3525 | 3679 | 4002 | 4389 | 4573 | 4573 | 4904 | 5031 | 5163 | 5292 | 5730 | 5858 | 5985 | 6112 |      |  |
| 2375        | 2709       | 2750 | 2884 | 2909 | 3087 | 3336 | 3444 | 3549 | 3704 | 4030 | 4420 | 4606 | 4606 | 4941 | 5070 | 5205 | 5335 | 5775 | 5906 | 5985 | 6165 |      |  |
| 2500        | 2887       | 2931 | 3115 | 3141 | 3196 | 3402 | 3543 | 3699 | 3831 | 4171 | 4591 | 4709 | 4709 | 5118 | 5256 | 5391 | 5522 | 5963 | 6093 | 6035 | 6360 |      |  |
| 2625        | 2899       | 2944 | 3130 | 3157 | 3306 | 3507 | 3650 | 3812 | 3980 | 4562 | 4769 | 4957 | 4957 | 5297 | 5438 | 5572 | 5706 | -    | -    | -    | -    |      |  |
| 2675        | 2903       | 2949 | 3136 | 3164 | 3312 | 3514 | 3659 | 3823 | 3990 | 4573 | 4782 | 4970 | 4970 | 5312 | 5453 | 5589 | 5724 | -    | -    | -    | -    |      |  |
| 2750        | -          | -    | -    | 3323 | 3526 | 3672 | 3837 | 4006 | 4590 | 4800 | 4990 | 4990 | -    | -    | -    | -    | -    | -    | -    | -    | -    |      |  |
| 2875        | -          | -    | -    | 3380 | 3678 | 3809 | 3960 | 4092 | 4732 | 4920 | 5139 | 5139 | -    | -    | -    | -    | -    | -    | -    | -    | -    |      |  |
| 3000        | -          | -    | -    | 3397 | 3698 | 3831 | 3984 | 4119 | 4761 | 4951 | 5172 | 5172 | -    | -    | -    | -    | -    | -    | -    | -    | -    |      |  |
| 3100        | -          | -    | -    | 3411 | 3713 | 3391 | 4003 | 4140 | 4783 | 4975 | 5198 | 5198 | -    | -    | -    | -    | -    | -    | -    | -    | -    |      |  |

Timber Effect Foil Coat only available in Golden Oak and Rosewood finish.

### Options for GaraRoll doors

|   |                          |
|---|--------------------------|
|   | <b>add</b>               |
| Surcharge for different colour frame and guides to door colour  | 159                      |
| Manually operated version (not possible on external fit)  | Price reduction 253      |
| Removal of barrel casing (optional only on door height 2500 mm and over)  | Price reduction per m 26 |
| External fit (reverse rolled)   | 115                      |
| Chamfered bottom profile available only in White or Colour.<br>Not available in timber effect finish  | per m 332                |
| Ventilation grilles or Glazing element with clear synthetic pane, window section<br>120 x 40 mm, black glazing frame on exterior, transparent on interior (maximum of<br>10 sections per door, number of glazing elements dependent on the door width) <sup>1</sup> | per m 42                 |

<sup>1</sup> Not available in top 6 laths.

### Accessories for GaraRoll operator

|  |            |
|--|------------|
|  | <b>add</b> |
| Bi-directional hand transmitter, 5-channel in black  | 93         |
| Bi-directional hand transmitter mini, 4-channel in black   | 79         |
| Motor connection line, 10 m - Reference No. 5498   | 60         |
| Acoustic door security kit - Reference No. 8671  | 99         |
| Emergency battery HNA 18 - Reference No. 8126  | 282        |
| Exterior emergency release - Reference No. 5501  | 152        |
| Additional fascia panel required when fitting a door within the opening, ordering size will need to be door size<br>plus guide width (price per metre) supplied in colour to match the door / guides | 77         |

All other operator accessories can be combined with GaraRoll roller doors. Please see page 73 to page 76.

GaraRoll is also available with a colour door curtain and white guide rails and box cover, at an additional cost of £166.  
If required, please state clearly on your order.



## Roller door fitting dimensions

### Fitting behind the opening

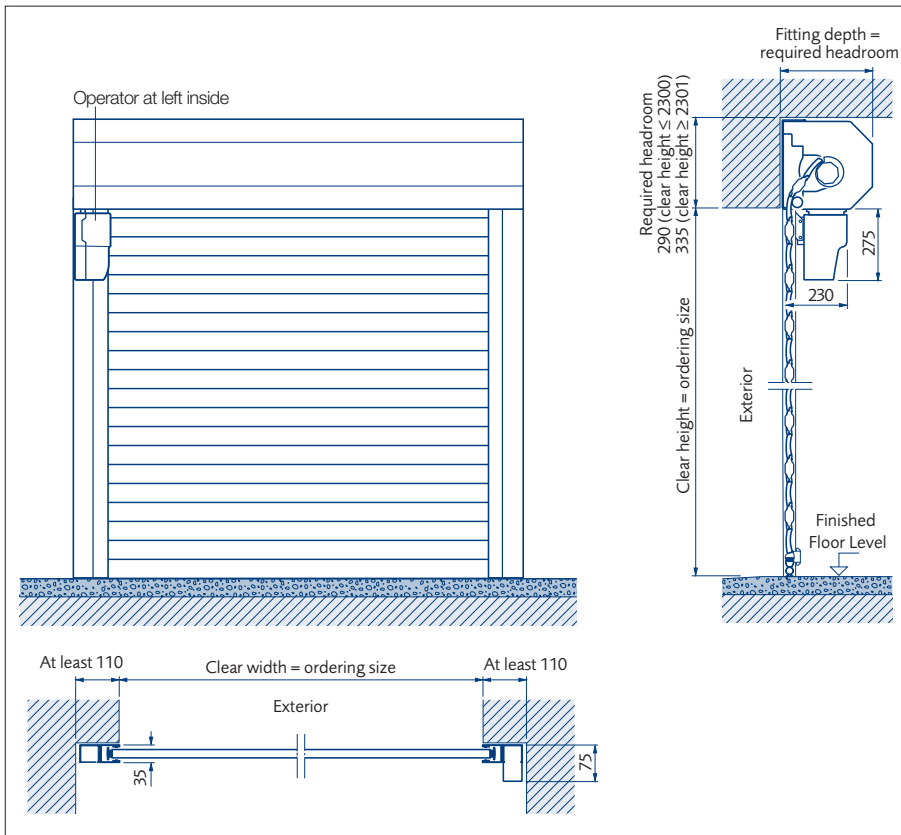

Clear passage width =  
clear width (ordering size)

Clear passage height =  
clear height (ordering size)  
– 80 mm for automated version,  
– 140 mm for manually operated version

### Fitting in the opening

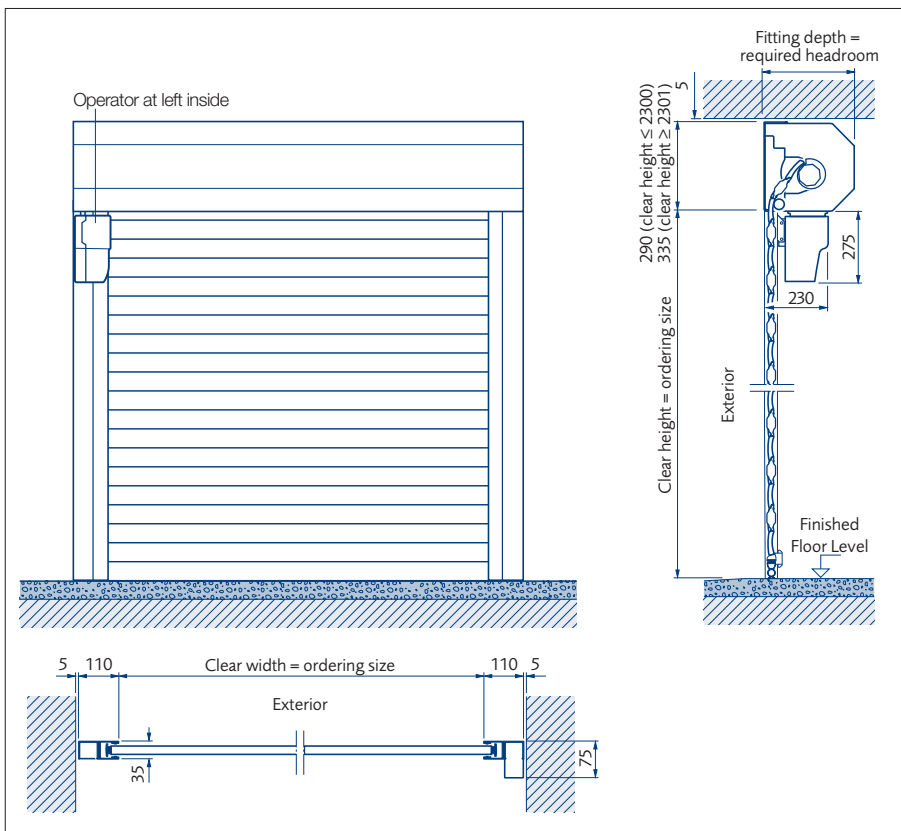

Clear passage width =  
clear width (ordering size)

Clear passage height =  
clear height (ordering size)  
– 80 mm for automated version,  
– 140 mm for manually operated version

# GaraGlide Roller Doors

A motor driven, roller garage door with tubular drive motor, closing edge safety device and manual hand crank for emergencies. The emergency release kit is not available for a retro-fit application so must be ordered with the original door. All doors are built to suit the opening, with the actual door size relating to the structural opening width x height and the guides fitting on the reveals to maintain a full opening size. Please refer to sizing tables for full range of size options.

## Door Curtain

77 mm rolled aluminium profile with 100 % CFC-free polyurethane rigid foam. Available in 16 standard colour, with a two-layer paint finish using a high-quality polyurethane paint coated with a polyimide. Each lath is 15 mm thick.

## Frame and Construction

75 mm guide rails for single doors and 105 mm for double doors. Guide rails are supplied in a colour to match the door curtain and with an integrated brush strip either side. The box cover, rollers and barrel are pre-assembled for convenience. Please state on your order if fitting between or behind opening.

## Operator and Control

GaraGlide operator and control included. 24 V DC gear drive, mains voltage 230 - 240 V AC, 0.5 KW, anti-lift kit, operator built into tubular drive with control board located on right as standard (viewed from inside) and impulse control. Operator with mechanically adjustable end-of-travel position. Included: 2 x bisecur 868 MHz hand transmitters and integral receiver, connecting lead with CEE plug, control buttons in cover of the control unit, integrated 2-minute garage courtesy light in control housing. The motor can be fitted either side. Also features an adjustable reversing procedure, adjustable pre-warning phase, adjustable automatic timer, connection of external illumination is possible and there is also a connecting option for a one-way photo cell.

## Standard Colours

GaraGlide roller doors are available in a choice of 15 standard colours, with the door curtain interior and exterior painted the same colour:

- Traffic White (RAL 9016)    - Steel Blue (RAL 5011)                    - Light Grey (RAL 7035)                    - White Aluminium (RAL 9006)
- Light Ivory (RAL 1015)    - Moss Green (RAL 6005)                    - Terra Brown (RAL 8028)                    - Grey Aluminium (RAL 9007)
- Ruby Red (RAL 3003)    - Slate Grey (RAL 7015)                    - Cream (RAL 9001)                    - Chartwell Green
- Purple Red (RAL 3004)    - Anthracite Grey (RAL 7016)                    - Jet Black (RAL 9005)

Anthracite Metallic (Noir 2100 Sable) is also available at an additional cost. See page 83 for additional colour options.

## Timber Effect Colours

A timber effect version is available in Golden Oak or Rosewood effect, where the exterior door curtain is coated in a UV-resistant synthetic foil with a timber effect design and embossed grain, and the interior of the door curtain is painted in Terra Brown (RAL 8028). A Deco Paint version is also available at a lower cost, where the laths are painted in a Golden Oak or Rosewood effect.

## Fitting

The GaraGlide is suitable for fitting between and behind a prepared brickwork opening.

## Packaging

GaraGlide roller doors are supplied in two twin-walled cardboard boxes for ease of transportation to site.

## Stock Availability

All GaraGlide doors are made to order with no standard sizes. Lead-time for all doors is 4 weeks.

Size range

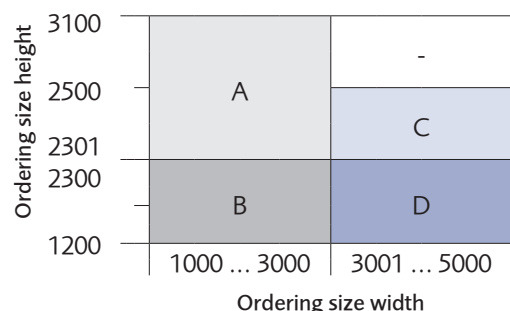

- A** Box 335, 75 mm guide rail, 70 mm shaft, no wind locks.
- B** Box 290, 75 mm guide rail, 70 mm shaft, no wind locks.
- C** Box 335, 105 mm guide rail, 80 mm shaft, with wind locks.
- D** Box 290, 105 mm guide rail, 80 mm shaft, with wind locks.

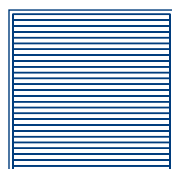

Smooth paint finish

| Door height | Door width |      |      |      |      |      |      |      |      |      |      |      |      |      |      |      |      |      |
|-------------|------------|------|------|------|------|------|------|------|------|------|------|------|------|------|------|------|------|------|
|             | 1000       | 1250 | 1500 | 1750 | 1900 | 2000 | 2250 | 2500 | 2750 | 3000 | 3250 | 3500 | 3750 | 4000 | 4250 | 4500 | 4750 | 5000 |
| 1200        |            |      |      |      |      |      |      |      |      |      |      |      |      |      |      |      |      |      |
| 1500        | 2122       | 2175 | 2199 | 2250 | 2250 | 2299 | 2349 | 2395 | 2466 | 2834 | 2882 | 2934 | 2978 | 3026 | 3090 | 3136 | 3189 |      |
| 1750        | 2158       | 2211 | 2248 | 2303 | 2303 | 2358 | 2415 | 2470 | 2543 | 2919 | 2975 | 3026 | 3080 | 3136 | 3204 | 3258 | 3314 |      |
| 2000        | 2185       | 2244 | 2288 | 2349 | 2349 | 2406 | 2461 | 2521 | 2602 | 2987 | 3044 | 3104 | 3163 | 3221 | 3295 | 3351 | 3411 |      |
| 2125        | 2196       | 2253 | 2299 | 2358 | 2358 | 2417 | 2480 | 2539 | 2618 | 3007 | 3067 | 3125 | 3189 | 3248 | 3323 | 3380 | 3444 |      |
| 2250        | 2211       | 2277 | 2321 | 2384 | 2384 | 2447 | 2514 | 2576 | 2656 | 3052 | 3115 | 3177 | 3241 | 3302 | 3380 | 3444 | 3504 |      |
| 2375        | 2241       | 2307 | 2358 | 2424 | 2424 | 2495 | 2563 | 2631 | 2717 | 3115 | 3180 | 3248 | 3314 | 3480 | 3561 | 3628 | 3697 |      |
| 2500        | 2250       | 2318 | 2372 | 2440 | 2440 | 2505 | 2579 | 2647 | 2737 | 3136 | 3207 | 3274 | 3346 | 3457 | 3595 | 3664 | 3730 |      |
| 2625        | 2288       | 2363 | 2420 | 2495 | 2495 | 2571 | 2647 | 2720 | 2816 | 3225 | 3299 | 3373 | 3447 | -    | -    | -    | -    |      |
| 2675        | 2288       | 2363 | 2420 | 2495 | 2495 | 2571 | 2647 | 2720 | 2816 | 3225 | 3299 | 3373 | 3447 | -    | -    | -    | -    |      |
| 2750        | 2288       | 2363 | 2420 | 2495 | 2495 | 2571 | 2647 | 2720 | 2816 | 3225 | 3299 | 3373 | 3447 | -    | -    | -    | -    |      |
| 2875        | 2321       | 2406 | 2470 | 2546 | 2546 | 2631 | 2708 | 2791 | 2894 | 3411 | 3487 | 3569 | 3650 | -    | -    | -    | -    |      |
| 3000        | 2321       | 2406 | 2470 | 2546 | 2546 | 2631 | 2708 | 2791 | 2894 | 3411 | 3487 | 3569 | 3650 | -    | -    | -    | -    |      |
| 3100        | 2321       | 2406 | 2470 | 2546 | 2546 | 2631 | 2708 | 2791 | 2894 | 3411 | 3487 | 3569 | 3650 | -    | -    | -    | -    |      |

Additional Colour Options

|  |                    |    |
|--|--------------------|----|
| Standard colours (choice of 15 colour options)                               | Included           |    |
| Anthracite Metallic (Noir 2100 Sable)  | per m <sup>2</sup> | 39 |
| Deco Paint (painted timber effect design in Golden Oak or Rosewood)          | per m <sup>2</sup> | 39 |
| Timber effect (plastic film coating in Golden Oak or Rosewood timber effect) | per m <sup>2</sup> | 70 |

Add £69 surcharge for external fit GaraGlide roller door.

Add £166 surcharge, to request the door curtain in one colour and the guide rails/box cover in an alternative colour. Please note there is no additional charge for a white frame.

Example of paint cost calculation:

For door dimensions of 2000 mm x 2125 mm, the door area is 4.25 m<sup>2</sup> (i.e. 2 x 2.125 = 4.25).

Multiply door area by cost per m<sup>2</sup> to calculate additional paint cost (i.e. 4.25 x 39 = £165.75).

Please note, dark colours should not be used for doors that are exposed to the sun. Despite the use of state-of-the-art colour coating systems, we cannot rule out colour deviations, specifically in metallic colours (RAL 9006 and RAL 9007).

Please state on your order if fitting between or behind opening.

External fit GaraGlide roller doors are only available up to 5000 mm wide and are not available in a timber effect finish.

GaraGlide is also available with a colour door curtain and white guide rails and box cover, at no extra charge. If required, please state clearly on your order.

## Roller door fitting dimensions

### Fitting behind opening

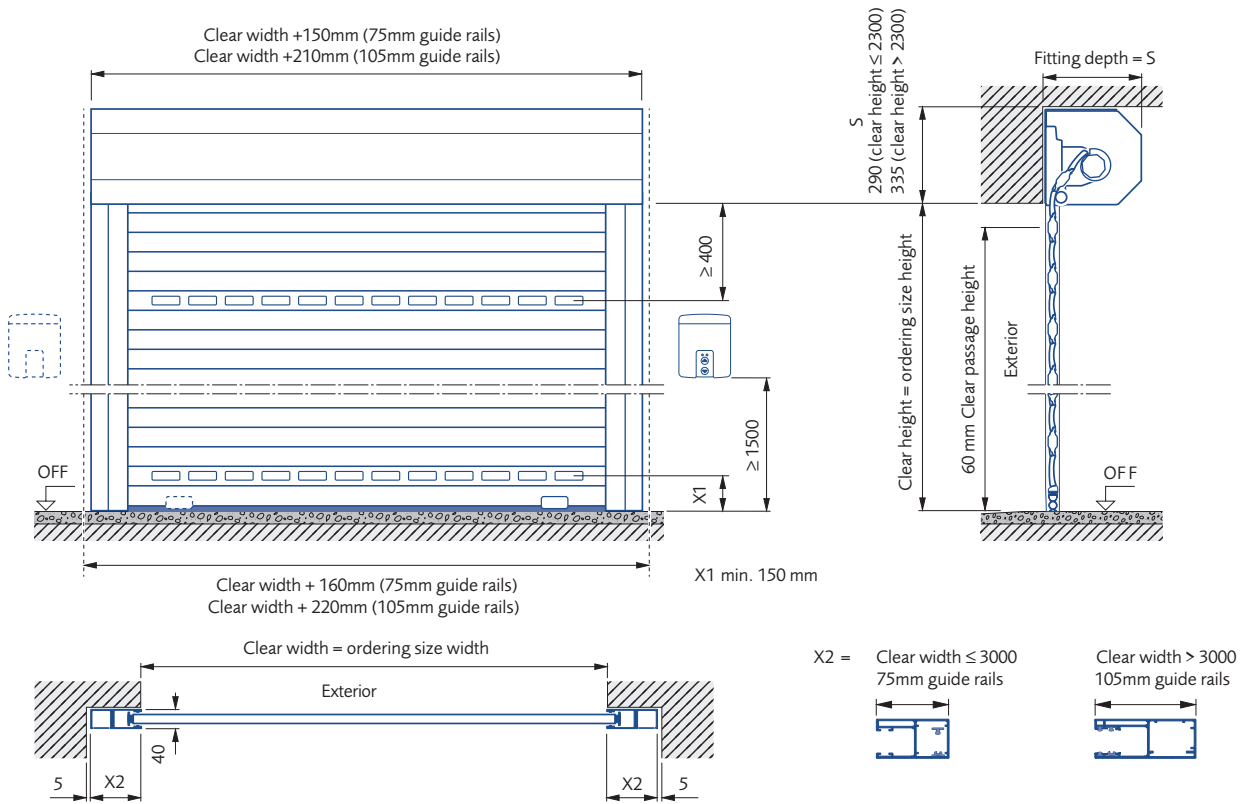

### Fitting between opening

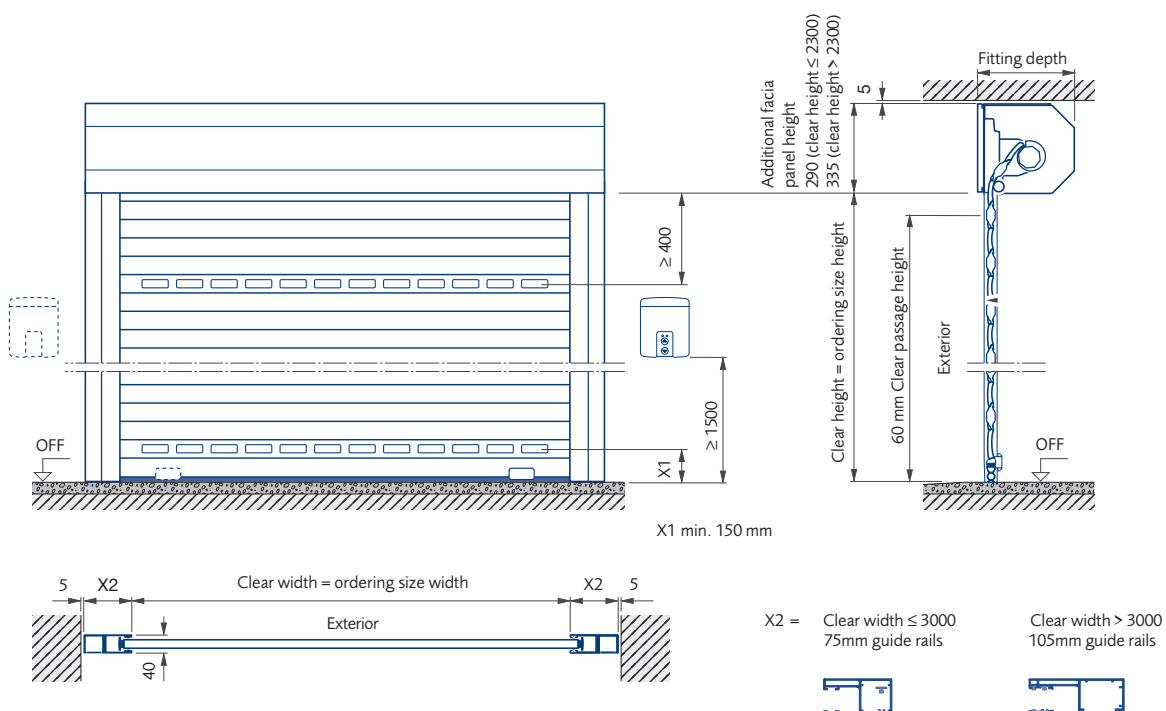

## Options for all GaraGlide roller garage doors

### Emergency Release

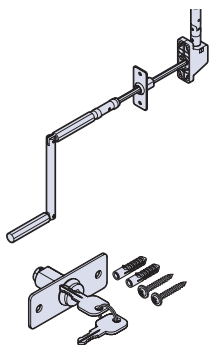

Exterior emergency release kit  
(Please note: the emergency release kit is not available for a retro-fit application so must be ordered with the original door).

each 277

### Ventilation Grilles and Glazing Elements

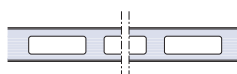

Glazing element (clear synthetic pane, window cut-out 112 mm x 33 mm)

per m 39



Ventilation grilles (black plastic with ventilation cross section approx 13 cm<sup>2</sup> / grille)

per m 39

### Additional Fascia Panel

Reinforcement of the fascia panel (required for fitting between opening)

per m 99

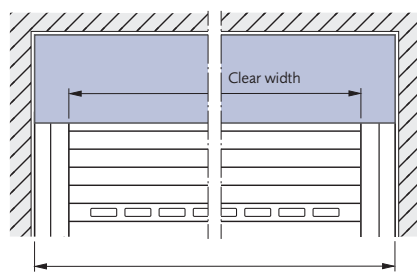
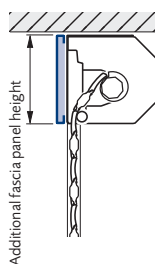
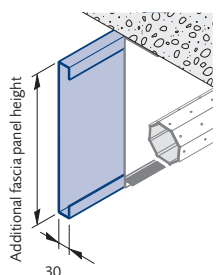

Additional fascia panel width = clear width +150 (75mm guide rails)  
Additional fascia panel width = clear width +210 (105mm guide rails)

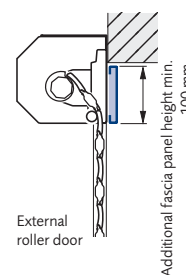
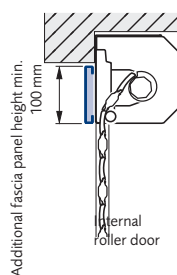

External fit (reverse rolled)

69

Operator with electronically adjustable end-of-travel positions

432

Wireless optical sensor

236

DuraBelt is available as an option when purchased with a new GaraGlide, or for retro-fitting to an existing GaraGlide:

#### DuraBelt (Optional)

|  |                    |     |
|--|--------------------|-----|
| 1000 mm - 1600 mm wide (2 winding units) | surcharge per door | 90  |
| 1601 mm - 3000 mm wide (3 winding units) | surcharge per door | 134 |
| 3001 mm - 5000 mm wide (5 winding units) | surcharge per door | 223 |

#### DuraBelt (Retro-Fitted)

|                                      |          |     |
|--------------------------------------|----------|-----|
| up to 2300 mm wide (2 winding units) | per door | 136 |
| up to 2300 mm wide (3 winding units) | per door | 204 |
| from 2301 mm wide (2 winding units)  | per door | 136 |
| from 2301 mm wide (3 winding units)  | per door | 204 |

# User Information / Care

A Garador garage door needs only a minimum level of preparation and maintenance to give years of trouble-free service. Below is a guide to how to get the best from your garage door.

## Operation

- For opening the door in manual operation use only the outside handle or inside handle. Never use the pull rope during the opening cycle of the door.
- For closing the door from the outside – the pull rope fixed to the internal handle is only designed to pull the door towards you whilst standing within the entrance of the garage until the door can be pushed down by hand, then using the external handle for final closing.
- For closing the door from the inside – the pull rope already mentioned is designed to be pulled away from you, when facing the front entrance of the garage, until the internal handle is able to be reached, by hand, and used for final closing. The pull rope is not designed to be used for any other part of the operating cycle, or any other purpose. Failure to comply with the above instructions may result in injury to persons or property.
- When the door is operated from either outside or inside, check the area through which the door will travel is clear from people and objects. Failure to do so may result in injury to persons or property.
- When closing, ensure the latches engage properly.
- If the door is power-operated always try to ensure you match the door with a GaraMatic electric operator.

## Power Operated Garage Doors

- It is against the Law to install a power operated garage door in the UK without complying with The Machinery Directive.
- To comply with the Machinery Directive both the door and the operator used in the Installation must have a declaration of Incorporation from the manufacturer.  
On completion of the installation the Installer must provide a Declaration of conformity and apply a CE mark giving details of the installation to the door/operator combination, which is now classed as a machine.
- The Installer must issue to the Customer a declaration of conformity on the completion of the installation.
- The Installer must hold copies of both the Declarations of Incorporation and the Declaration of Conformity on a technical file for inspection by the relevant authorities.
- If any of the above requirements are not fulfilled the Installation is illegal.
- Please ensure for your own safety and peace of mind that whoever installs your electric operator is both willing and able to fulfil these requirements; if they are not do not use them !!
- Members of the DHF CAN and WILL install your operator safely and legally.

## Cleaning

- The door and frame if applicable, should be washed with a mild soap-based solution on a regular basis to prevent the build up of dirt, salts and other corrosive substances and help maintain the aesthetic appearance of the product.
- If the door is installed in a coastal location, the door panel and frame should be cleaned in this way at least every two months.
- We also suggest that all other components be brushed down on a regular basis to prevent the build up of dirt and dust etc.
- On GaraRoll roller doors regular removal of dirt and debris is required to avoid damage to laths when the curtain rolls.

## Locking

- If the key is turned completely, the door is then locked or unlocked; when unlocked it is then possible to open and close the door by turning the handle.
- If the key is turned 1/4 of the way, the door opened and then the key returned to its start position, the door will re-lock when closed.
- By moving the internal locking "snib", it is possible to lock and unlock the door from the inside without using the key, except on SBD doors where there is no internal snib/locking system.

## Maintenance

- If in doubt about any of these maintenance procedures below always consult a Garador specialist. Garador Ltd. has a nationwide network of installers who will be able to offer you a regular maintenance service on your garage door. Please call Garador or refer to the Garador website for further details of your nearest installer.
- Immediately after the door is fitted and after every 5,000 operations of the door, or at least once a year, oil all pivot points, check screws and clamped connections for tightness, keep the running tracks clean (do not grease them), check parts and replace any worn components where necessary.
- The springs should be replaced after approx. 25,000 operations by an experienced door fitter (see fitting and operation instructions).
- Do not oil the lock cylinder; if it is sticking, only lubricate with graphite dust.
- For canopy doors only, check the cable every 6 months with normal usage (8 operations per day). Have the cables replaced by an expert if any wear is found.

#### **Finish – Steel Doors**

The coating process applied to the door and chassis is environmentally friendly. Minor scratches or marks are not covered under the conditions of our warranty and should be repaired immediately to prevent corrosion and deterioration of the panel. Corrosive substances such as acids, alkalines, and salts, etc. should be cleaned from the door immediately; failure to do so will result in deterioration of the finish, which will not be covered under our warranty. Garador steel doors are finished products. They do not require immediate painting on-site. They are however not immune to damage, which can occur at any stage of the handling of the product from factory to site. Should deterioration of the finish start to occur you will need to repaint your door immediately. Prepare the surface lightly with wet and dry. Then treat with solvent based 2 pack epoxy wash primer and a normal commercial paint (cellulose paint must not be used).

Minor surface damage can easily be repaired using touch up sprays or paint sticks without invalidating your warranty.

#### **Finish – Timber Doors**

Timber panels are coated with a neutralising base-stain. Doors must be stored upright, under cover in a dry location, with wrapping intact, until wrapping is removed. As soon as the door is unwrapped, one coat of a good quality basecoat primer must be applied to both sides of the door. Immediately after installation, your timber doors require a further two coats of a good quality exterior wood finish on both sides.

Initial application and periodic treatment should be carried out strictly in accordance with the woodstain manufacturer's instructions.

Failure to follow these instructions will result in early deterioration of the timber panel which would not be covered under our warranty.

#### **Finish – GRP Doors**

GRP door panels should be periodically washed down using water. This should be done more frequently if fitted in a coastal location.

Bird droppings will bleach the finish on GRP and should be removed using water as soon as possible.

GRP doors should not be painted over.

# Warranty

Garador products are manufactured to the highest quality standards and leave our factory only after rigorous quality testing. However, if you should have grounds for complaint, this section tells you what our door warranty offers, and how to go about making your claim.

In the unlikely event of a warranty claim becoming necessary, please contact the dealer or distributor who originally supplied your garage door. Your dealer should then supply details of the claim, together with a copy of the warranty card provided with the door and proof of purchase to the Warranty Department at Garador Ltd.

To enable your claim under warranty to be processed as quickly as possible, you should provide the following details:

- 1 Your name, address and telephone number
- 2 Original invoice with date of purchase
- 3 Product description/door type and product number
- 4 Description of defect

An assessment of the claim will then be made. This may require Garador to inspect the product in-situ. In the event that there is no legitimate warranty claim under the terms specified herein, you may be liable for the costs of the inspection visit. We strongly recommend that you take note of the care and usage instructions displayed on the stickers on the back of your garage door and on the previous page and that you follow these instructions throughout.

## Garador installers

Garador Ltd. has a nationwide network of recommended installers who will be able to offer you a regular maintenance service on your garage door. Please call us on 01935 443722 or refer to the Garador website for further details of your nearest installer.

## Garador Garage Door Warranty

### Warranty Period

The purchaser is granted a warranty covering the safe and reliable function of the Garador garage door for a period of 10 years from the date of purchase. A 5 year warranty applies to springs, wire cables, track rollers, hinges and guide rollers. The warranty period for replacement parts is 6 months or to the end of the current warranty period, whichever is longer.

In the case of foil-coated timber effect and PVC doors, a warranty of 5 years is granted, for timber and GRP doors a warranty of 2 years is granted on the door panels alone under the terms and conditions specified herein. The door mechanism and steel frame (if applicable) is covered by the 10 year warranty period.

### Requirements

Warranty claims are only applicable in the country where the garage door was purchased. The product must have been purchased through our authorised distribution channels. The warranty only covers damage to the contract object. The fully completed warranty card together with the receipt of purchase correspondingly dated substantiates your right to claim under the warranty.

### Performance

During the warranty period we undertake to rectify any and all defects to the Garador product which can be proved to be attributed to a material or manufacturing fault.

We pledge at our discretion either to exchange the defective merchandise for faultless merchandise, repair it or allow a reduction in price. We do not accept costs for dismantling and installation nor for carriage.

Replaced parts become our property.

The warranty does not cover damage caused through:

- normal wear and tear
- improper installation
- negligent care and maintenance
- improper initial and subsequent operation
- negligent or wanton destruction
- external influences such as fire, water, salts, alkaline solutions, acids, abnormal environmental influences
- mechanical damage through improper transport and fitting
- priming and other surface protection treatments
- incorrect or too late applied surface protection treatments
- repair by non-qualified persons
- using non-Garador parts without the approval of the manufacturer
- Removal of the product number or making it unidentifiable

### Warranty GaraRoll and GaraGlide

GaraRoll and GaraGlide roller doors are subject to a limited 10 year warranty. The design of these doors represents state of the art technology. Pressure marks and abrasive wear, particularly on the top profiles are a condition of the design and cannot be avoided. They are not considered a reason for complaint.

In order to avoid excessive friction, remove any dirt and debris from the door curtain at regular intervals. For motors and controls, see warranty below.



In addition to the statutory warranty provided by the dealer in the sales contract, we grant the following warranty for parts from the date of purchase:

- 5 years on operator technology, motor and motor control.
- 2 years on radio equipment, accessories and special systems.

Claims made under the warranty do not extend the warranty period. For replacement parts and repairs the warranty period is six months or at least the remainder of the warranty period.

General wear and tear:

Due to the design of the roller door, the inside of the door curtain will exhibit some marks after a short period of time. This is classed as general wear and tear that you would expect to see over a period of months or years. It is not detrimental to the door's performance and would therefore not be grounds for a warranty claim.

Pre-requisites:

The warranty claim only applies in the country where the equipment was purchased. The product must have been purchased through our authorised distribution channels. A claim under this warranty exists only for damage to the object of the contract itself. The receipt of purchase substantiates your right to claim under the warranty.

Services:

For the duration of the warranty we shall eliminate any product defects that are proven to be attributable to a material or manufacturing fault. We pledge to replace free of charge and at our discretion the defective goods with non-defective goods, to carry out repairs, or to grant a price reduction. Replaced parts become our property. Reimbursement of expenditure for dismantling and fitting, testing of parts as well as demands for lost profits and compensation for damages are excluded from the warranty.

Damage caused by the following is also excluded:

- improper fitting and connection
- improper initial start-up and operation
- external factors such as fire, water, abnormal environmental conditions
- mechanical damage caused by accidents, falls, impacts
- negligent or intentional destruction
- normal wear or deficient maintenance
- repairs conducted by unqualified persons
- use of non-original parts
- removal or defacing of the data label

#### Electric Operator Warranty

A separate 5 year warranty is granted on our electric operators. This includes operator mechanics, motor and motor control systems. A 2 year warranty is granted on radio equipment, accessories and system controls. There is no warranty on consumables (e. g. fuses, batteries, bulbs etc.). For further details please contact us on 01935 443722, or through our website on [www.garador.co.uk](http://www.garador.co.uk)

# Extracts from DHF consumer advice

The following document has been created by the Door and Hardware Federation (DHF) and endorsed by all major UK garage door manufacturers, as a guide for purchasers and domestic garage doors.

## Visual Appearance of Garage Doors

A new garage door can be a significant investment that will transform the appearance of your home. This information is a guide to the quality you can expect.

### The Quality Check

The quality check should be carried out in natural daylight, not direct sunlight. Stand at a distance of 3 metres from the door to view the overall appearance. The door is acceptable if, taking into account the facts below, none of the following are readily visible on the face of the door:

- Marks or distortion associated with the manufacturing process
- Minor indentations, marks or scuffs on the surface
- Paint or stain blemishes

## The Facts

### Steel Doors

- Panel Distortion

The rolling or pressing of steel panels during manufacture will cause distortion in the steel and while every effort is made to keep this to a minimum, inevitably some visible distortion will remain. The application of high gloss paints will make this slight distortion more apparent, especially under certain lighting conditions, such as car headlamps, or bright sunshine.

- Paint Finish

Primed doors – the primer coating is applied as a base coat only and as such requires additional finishing with a good quality exterior paint.

Any marks or scratches on the primer coat should be rubbed down and repainted as part of this finishing process.

Finished doors – the factory application of the paint finish is an automated process and this may result in minor blemishes or slight inconsistencies in the paint, particularly in the area of panel joints.

### Timber Doors

- Timber

Timber is a natural product and there will be variations in pattern, colour, shading and grains. No two doors will be the same. Wood naturally expands and contracts according to environmental conditions, joints will open and close and some minor curvature may occur.

- Finishing

It is vital that timber doors are fully finished as per the manufacturers instructions before exposure to the elements.

### GRP and composite Plastic Doors

- Mould Marks

GRP doors are individually handcrafted in a mould and are then hand finished. Some minor marks and blemishes will inevitably remain after this process.

- Translucency

When viewed from the inside, it is often possible to see variations in the translucency of the door, particularly around and between areas of relief. Such variations do not detract from the overall strength or build quality of the door.

### All Doors

- Colour Match

Pairs of doors should be ordered together to obtain the best colour match, bearing in mind the limitations of the materials used in the construction.

Timber garage doors cannot be ordered as matching sets.

- Size Variations

As the size of a door changes in height and/or width, the panel frequency and profile can change, therefore doors of the same style but of different sizes can be significantly different in appearance.

- Clearances

All doors require operating clearances, i.e. the gap between the door panel and the frame opening, these are inbuilt during manufacture and should not be reduced by means of infills, or draughtproofing.

- Deflection

When in the open position, all doors will display a level of vertical deflection or 'sag' across the width of the panel. Individual manufacturers' specifications should be consulted for exact tolerances.



# GARADOR

*The Garage Door People*

Bunford Lane, Yeovil, Somerset, BA20 2GL  
Tel: (01935) 443722 Fax: (01935) 443744

[www.garador.co.uk](http://www.garador.co.uk)



Garador is the UK's leading manufacturer of garage doors and operators, with an ultra-modern production facility located in Somerset. We use German engineering expertise to produce highly sophisticated doors and operators. By purchasing a Garador product you can be assured of the highest level of quality, safety and security. With a nationwide network of stockists, installers and service technicians we are an ideal partner for your project.